



Historic Bridge Management Plan for the Calcasieu River (Moss Bluff) Bridge

Recall Number: 031736

Structure Number: 07100240103501

Parish: Calcasieu

Route: US 171

Crossing Description: Calcasieu River



Prepared for

**Louisiana Department of
Transportation and
Development**

Prepared by

**Mead
& Hunt**

www.meadhunt.com

June 2017

THIS PAGE INTENTIONALLY LEFT BLANK

Table of Contents

	Page
Executive Summary	1
1. Introduction	3
2. Location Map	5
3. Historic Data	7
A. Identifying information	7
B. Description of bridge	7
C. History and significance	8
D. Character-defining features	9
4. Engineering Data.....	15
A. Existing conditions	15
(1) Structural observations	15
(2) Non-structural observations	16
(3) Serviceability observations.....	16
B. Sources of information.....	17
5. Recommendations	27
A. Preventative maintenance	27
B. Rehabilitation	28
C. Identification of any anticipated design exceptions	28

Appendices

- A Historic Inventory Form
- B Select Plan Sheets

THIS PAGE INTENTIONALLY LEFT BLANK

Executive Summary

The Calcasieu River (Moss Bluff) Bridge (Recall No. 031736) is located in east-central Calcasieu Parish just outside the northern city limits of Lake Charles, Louisiana, and is owned by the State of Louisiana. The bridge was completed in 1969 and was determined eligible for the National Register of Historic Places (National Register) in 2013. It is significant as a steel and plate girder concrete bridge that demonstrates exceptional significance for the length of its main spans and also its notable overall length. The bridge's five main plate girder spans, two at 150 feet and three at 200 feet, are considered exceptional main span lengths for steel plate girder bridges. The bridge also has a notable overall length of 5,702 feet.

The bridge carries U.S. Highway (US) 171 across the Calcasieu River. The 5,702-foot crossing consists of five steel plate girder spans and 72 precast prestressed concrete girder approach spans. Spans 13 through 17 comprise the main spans—a five-span steel deck plate girder—with a total length of 900 feet, with cast-in-place, reinforced-concrete decks. The five spans consist of two 150-foot-long spans and three 200-foot-long spans. These main steel girder spans are continuous, with hinged hangers and pins near each end of the center span. A timber fender system for waterway navigation extends into the waterway east and west of the steel plate girder spans, under the center span, and provides for a clear horizontal navigation width of 125 feet. The center span provides for 35 feet vertical clearance from high water elevation to bottom of low steel. The bridge is classified as a complex structure because it contains a two steel girder system with pin and hangers, which makes the steel girder spans of this structure fracture critical.

The bridge is in good condition and appears to adequately serve its purpose of carrying vehicular traffic over the waterway. The major deficiency is the failure of the paint system for the main steel plate girder superstructure spans. With proper maintenance and rehabilitation, the Calcasieu River (Moss Bluff) Bridge can continue to serve in its present capacity for 20 years or longer.

Any work on the bridge should proceed according to recommendations in this Historic Bridge Management Plan (Plan), which adhere to the *Secretary of the Interior's Standards for the Treatment of Historic Properties* (Secretary's Standards), the *Management Plan for Historic Bridges Statewide* (Statewide Historic Bridge Plan), and the *Programmatic Agreement among the Federal Highway Administration, the Louisiana Department of Transportation And Development, the Advisory Council on Historic Preservation, and the Louisiana State Historic Preservation Officer Regarding Management of Historic Bridges in Louisiana* (PA).

THIS PAGE INTENTIONALLY LEFT BLANK

1. Introduction

This Plan, used in conjunction with the Statewide Historic Bridge Plan, provides guidance on the approach to preservation activities for the Calcasieu River (Moss Bluff) Bridge (Recall No. 031736), identified as a Preservation Priority Bridge. Completion of individual management plans for Preservation Priority Bridges and the Statewide Historic Bridge Plan fulfills terms of the PA, which was executed on September 21, 2015.

The PA provides the basis and procedures for the management of historic bridges in Louisiana and outlines the procedures for the treatment of historic bridges, including Preservation Priority Bridges. In accordance with the PA, an owner seeking state or federal funding for Preservation Priority Bridges will be required by the Louisiana Department of Transportation and Development (LADOTD), in cooperation with the Louisiana State Historic Preservation Office (LASHPO) and the Federal Highway Administration (FHWA), to follow the procedures outlined in this Plan and the Statewide Historic Bridge Plan.

The Statewide Historic Bridge Plan outlines the overall approach to bridge preservation through a discussion of the collaboration of the historian and engineer, guidance on assessing preservation needs, and resources and technical guidance on maintenance and rehabilitation activities that are broadly applicable to historic bridges. A glossary of common engineering and historical terms is included in the Statewide Historic Bridge Plan.

This Plan for the Calcasieu River (Moss Bluff) Bridge compiles and summarizes the specific historic and engineering information for this Preservation Priority Bridge. It documents the existing use and condition of the bridge, along with assessments of the preservation needs, including cost estimates. Preservation can be accomplished in two manners: preventative maintenance and rehabilitation. Maintenance includes cyclical or condition-based activities that, along with regular structural inspections, are directed toward continued structure serviceability. Rehabilitation activities are near- or long-term steps that need to be taken to preserve and in some cases restore a bridge's structural condition and serviceability. In assessing preservation activities for each Preservation Priority Bridge, a design life of 20 years was considered, which is consistent with the duration of the PA. This Plan provides the bridge owner, and other interested parties, with detailed information related to the historic nature of the bridge and the necessary background to make an informed planning decision. Recommendations within this Plan should be reviewed in 10 years following completion of the Plan to identify any needed updates or revisions.

Existing bridge data sources typically available for Louisiana bridges were gathered for this Plan, and field investigation confirmed the general structural condition and character-defining features of the subject bridge. These sources include:

- The current LADOTD Bridge Inspection Report, and any other similar inspection reports
- Original bridge construction plans, any rehabilitation plans, and record as-built plans, as available
- Existing historical and documentary material related to the historic bridges

Recommendations within this Plan are consistent with the Secretary's Standards. The Secretary's Standards are basic principles created to help preserve the distinct character of a historic property and its site, while allowing for reasonable change to meet new engineering standards and codes. The Secretary's Standards recommend repairing, rather than replacing, deteriorated features whenever possible. A version of the Secretary's Standards that is specific to historic bridges is included in the Statewide Historic Bridge Plan. Following these standards is a requirement of the PA.

A bridge historian and bridge engineer from Mead & Hunt, Inc. (Mead & Hunt) jointly prepared this Plan under contract to the LADOTD. The LADOTD, FHWA, and LASHPO reviewed and provided input into the final Plan.

2. Location Map

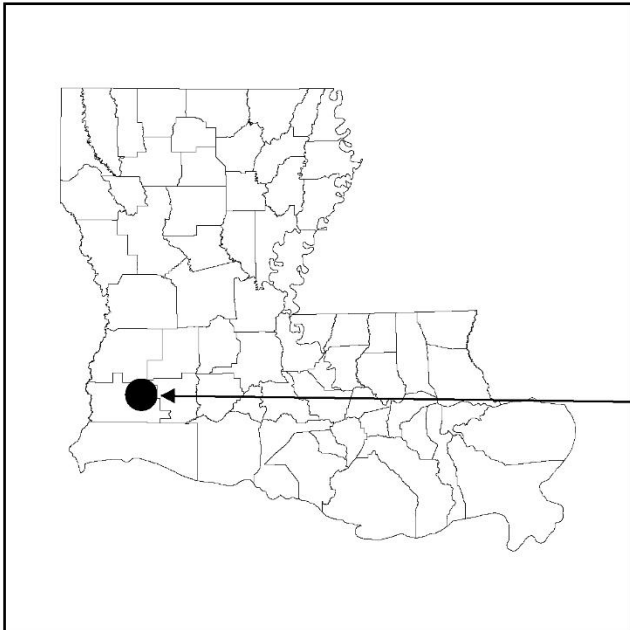
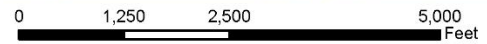

PROJECT LOCATION
Bridge Number: 031736
Stucture Number: 07100240103501
Calcasieu Parish
Route: US 171
Crossing Description: Calcasieu River

THIS PAGE INTENTIONALLY LEFT BLANK

3. Historic Data

A. Identifying information

Structure Number: 07100240103501

Recall Number: 031736

LASHPO Number: 10-00392

Bridge Name: Calcasieu River (Moss Bluff) Bridge

Date of Construction: 1969

Main Span Type: Post-1945 Common Type: Steel plate girder

Contractor: F. Miller and Sons, Lake Charles, La. (Construction)

Designer/Engineer: Louisiana Department of Highways
Dunham-Price Co., Lake Charles, La. (Concrete beams and bents)
Mosher Steel Co., Houston, Tx. (Steel plate girder spans)

B. Description of bridge

The Calcasieu River (Moss Bluff) Bridge carries US 171 across the Calcasieu River in Calcasieu Parish. The average daily traffic (ADT) across the bridge is approximately 28,000 vehicles. The 5,702-foot crossing consists of five steel plate girder spans and 72 precast prestressed concrete girder approach spans. The bridge is not load (weight) posted. The bridge is classified as a complex structure because it contains a two steel girder system with pin and hangers, which makes the steel girder spans of this structure fracture critical.

The total length of the bridge is approximately 5,702 feet measured from end bent to end bent. The overall bridge length includes approximately 1 foot on both sides from the end of the bridge to the beginning of the approach roadway. The bridge is described as follows, from south to north. Spans 1 through 12 are precast prestressed concrete girder spans with cast-in-place, reinforced-concrete decks. Spans 1 through 8 are each 65 feet long for a total length of 520 feet, spans 9 through 11 are each 80 feet long for a total of 240 feet, and span 12 is 80 feet long. Spans 13 through 17 comprise the main spans—a five-span steel deck plate girder—with a total length of 900 feet, with cast-in-place, reinforced-concrete decks. The five spans consist of two 150-foot-long spans and three 200-foot-long spans. These main steel girder spans are continuous, with hinged hangers and pins near each end of the center span. Two lines of girders support each half of the roadway, with the roadway separated by an open joint. Spans 18 through 77 are precast prestressed concrete girder spans with cast-in-place, reinforced-

concrete decks. Span 18 is 80 feet long, spans 19 through 21 are each 80 feet long for a total of 240 feet, and spans 22 through 77 are each 65 feet long for a total of 3,640 feet.

The steel plate girder spans consist of two parallel steel plate girders with steel floorbeams, steel stringers, and steel pin and hanger assemblies near each end of the center span. There are two 150-foot-long spans and three 200-foot-long spans with a finger joint at either end of the span and over the pin and hanger assemblies. The bridge provides two 28-foot clear roadway widths, one roadway for northbound traffic and one roadway for southbound, with a 1-foot-6-inch sidewalk in each direction on the outside edges of the bridge. The bridge railings and median barrier are both concrete.

The substructure for the approach spans consist of cast-in-place concrete end bents supported on 18-inch-square precast concrete piles and cast-in-place, reinforced-concrete bent caps supported on 24-inch- or 30-inch-square precast concrete piles that form the columns. The substructure for the main span consists of cast-in-place, reinforced-concrete wall-type piers supported on 24-inch- or 30-inch-square precast concrete piles.

A timber fender system for waterway navigation extends into the waterway east and west of the steel plate girder spans, under the center span. The timber fender system provides for a clear horizontal navigation width of 125 feet. The center span provides for 35 feet vertical clearance from high water elevation to bottom of low steel.

C. History and significance

The Calcasieu River (Moss Bluff) Bridge is located in east-central Calcasieu Parish just outside the northern city limits of Lake Charles, Louisiana. It carries US 171 (N. Martin Luther King Highway) over the Calcasieu River. US 171 begins in Lake Charles at its intersection with US 90 and runs north, providing a connection to Shreveport, Louisiana, ending at the intersection with US 79 in Shreveport.

Preliminary plans by the Louisiana Department of Highways for the bridge began in 1962 as part of a larger relocation and overall improvement program for US 171.¹ The plans called for shifting the alignment of US 171 and replacing an existing 1923 wood and steel bridge approximately one-half mile upstream. The project also involved replacing the bridge carrying US 171 over the English Bayou just south of the Calcasieu River crossing.²

The deteriorating 1923 bridge over the Calcasieu River was a concern from the start of the project. In May 1963 the Calcasieu Parish Police Jury passed a resolution requesting the highway department to give the project the “highest priority” because the existing bridge was too narrow and extremely

¹ “New Calcasieu River Bridge Planned on 171,” *Lake Charles American Press*, September 27, 1962.

² “Moss Bluff Bridge is Falling Down,” *Lake Charles American Press*, January 3, 1966; “Three Bridges to be Built in Calcasieu,” *Lake Charles American Press*, January 7, 1966.

hazardous.³ In June 1964 Louisiana Highway Director A.L. Stewart pledged that the project would receive top priority, stating the plans and specifications for the bridge were underway and would be completed within six months.⁴ In January 1966 concerns that the existing bridge would “cave in” led to the Calcasieu Parish Police Jury to again request that the highway department expedite the construction of the new bridge.⁵ That same month Stewart announced that the contract for construction of the bridge would be let in May, as makeshift supports were being used under some of the pilings on the existing bridge.⁶

Work began on the bridge in 1967.⁷ Construction was performed by F. Miller and Sons of Lake Charles (which also completed the English Bayou crossing as part of the project), and the project reportedly progressed at an accelerated pace.⁸ Beams and bents for the bridge were fabricated by Dunham-Price Co. of Lake Charles, while steel was fabricated by Mosher Steel Co. of Houston, Texas.⁹ The bridge was completed in 1969 at a total cost of just under \$4.5 million.¹⁰

The Calcasieu River (Moss Bluff) Bridge is eligible for the National Register under *Criterion C: Design/Engineering*. The bridge conveys exceptional significance for the length of its main spans and also notable overall length. The steel plate and concrete girder bridge has five main plate girder spans; two are 150 feet and three are 200 feet, which are considered exceptional main span lengths for steel plate girder bridges. Steel plate girders consist of built-up welded plates with a deep web that lies between the top and bottom flanges, which are fabricated by plate steel placed horizontally over the webs of the girder. The bridge also has a notable overall length of 5,702 feet. It retains good integrity.

D. Character-defining features

Character-defining features are prominent or distinctive aspects, qualities, or characteristics of a historic property that contribute significantly to its physical character. Features may include materials, engineering design, and structural and decorative details. Elements of the bridge that are not identified

³ Buddy Threatt, “Highest Priority for Bridge Asked,” *Lake Charles American Press*, May 7, 1963.

⁴ “Proposed Moss Bluff Bridge is Given Priority,” *Lake Charles American Press*, June 4, 1964.

⁵ “Moss Bluff Bridge is Falling Down.”

⁶ “Three Bridges to be Built in Calcasieu.”

⁷ “Parish Highway Construction Totals 245 Miles in 3 years,” *Lake Charles American Press*, May 24, 1967.

⁸ “Accelerated Pace is Reported for English Bayou, Moss Bluff Bridges,” *Lake Charles American Press*, February 6, 1967.

⁹ “A. of C. Unit Pays Visit to Concrete Plant,” *Lake Charles American Press*, May 13, 1967; Mosher Steel Company, shop drawings of the Calcasieu River Bridge, 1966.

¹⁰ State of Louisiana, Department of Highways, *Financial & Statistical Report, Fiscal Year Ending June 30, 1967* (Baton Rouge, La.: Department of Highways, 1967), 64; State of Louisiana, Department of Highways, *Financial & Statistical Report, Fiscal Year Ending June 30, 1968* (Baton Rouge, La.: Department of Highways, 1968), 59; State of Louisiana, Department of Highways, *Financial & Statistical Report, Fiscal Year Ending June 30, 1969* (Baton Rouge, La.: Department of Highways, 1969), 41; State of Louisiana, Department of Highways, *Financial & Statistical Report, Fiscal Year Ending June 30, 1970* (Baton Rouge, La.: Department of Highways, 1970), 44.

as character-defining features may be historic fabric. Historic fabric is material in a bridge that was part of original construction. It is important to consider both character-defining features and the bridge's historic fabric when planning any work.

The Calcasieu River (Moss Bluff) Bridge has one character-defining feature: its superstructure, including the five steel plate girder spans demonstrating exceptional main span length and the concrete approach spans (described below). Other elements that represent historic fabric but are not considered to be character-defining are the concrete substructure elements, including the bents and piers, and the concrete railing and center median barrier.

The following item is the character-defining features of this bridge:

Feature 1: Design and construction of the steel plate girder and concrete beam superstructure

This feature includes the entire superstructure measuring 5,702 feet, including the five main steel plate girder spans and the 72 precast prestressed concrete girder approach spans. The five main steel plate girder spans totaling 900 feet (two at 150 feet and three at 200 feet) are considered exceptional main span lengths of their span type.



Character-defining Feature Photo 1: Design and construction of the steel plate girder and concrete girder superstructure. The concrete approach spans and five steel plate girders spans demonstrate exceptional main span length.



Character-defining Feature Photo 2: Design and construction of the steel plate girder and concrete girder superstructure.



Character-defining Feature Photo 3: Design and construction of the steel plate girder and concrete girder superstructure. View of the underside of the steel plate girder main spans.



Character-defining Feature Photo 4: Design and construction of the steel plate girder and concrete girder superstructure. View of the concrete approach spans.

The following images illustrate other bridge features that are historic fabric, meaning they are part of original construction but are not considered to be character-defining features:



Historic Fabric Photo 1: Concrete bents for approach spans.



Historic Fabric Photo 2: Concrete piers for main steel plate girder spans.

THIS PAGE INTENTIONALLY LEFT BLANK

4. Engineering Data

A. Existing conditions

(1) Structural observations

The Calcasieu River (Moss Bluff) Bridge is in good condition and appears to adequately serve its purpose of carrying vehicular traffic over the waterway. The major deficiency is the failure of the paint system for the main steel plate girder superstructure spans.

The bridge is not load (weight) posted.

Approach spans (spans 1-12 and 18-77)

The cast-in-place, reinforced-concrete decks of the approach spans are in satisfactory condition with minor wear showing on the driving surface, and both longitudinal and transverse cracks. The underside of the deck exhibits hairline cracks. The strip seals in the deck joints are in good condition. Some of the joint material has failed and is hanging from the joint. The pourable deck joint seals at the abutments are in good condition with minor localized failures. The concrete bridge rail and median barrier are in satisfactory condition exhibiting minor cracking and exposed aggregate.

The precast prestressed concrete girders are in good condition with exterior girder discoloration due to weather exposure. There are deck drains and numerous dirt dauber nests present in all approach spans. Girder 1 at bent 5 exhibits minor cracking and shear. Girder 8 at bent 7 has noted delaminations. Minor shear cracks are present at the end of the girders at the bents and the concrete pads under the elastomeric pads have cracked at the edges in spans 18 through 77.

The reinforced-concrete end bents are in good condition with minor hairline cracking, spalling with exposed reinforcing, and discoloration. The sack revetment slope protection is in good condition with no displacement. The square prestressed concrete piles (columns) of the bents are in good condition with minor surface spalls and vegetation growth up the column. The bent piles (columns) and concrete caps in spans 1 through 12 are in good condition. The bent piles (columns) in spans 18 through 77 located in the marsh area are exhibiting exposed aggregate at the bottom of the column. The cast-in-place, reinforced-concrete bent caps are in good condition. There is a large amount of debris on top of the caps between girders 4 and 5 in spans 1 through 12 and between girders 5 and 6 in spans 18 through 77 due to the location under the median. Old joint material is also laying on the caps. The caps are discolored due to water staining and exposure to weather. The bent 9 cap has hairline transverse cracks and the west side of the bent 28 cap has a 1-foot vertical concrete popout with exposed reinforcing. The elastomeric bearings for the girders are in good condition. Bent 1 has numerous anchor bolt nuts missing. The bearing pad at girder 6 at bent 6 has 2 inches of movement recorded, and at bent 38 the bearing pad at girder 2 has 3/4-inch of movement recorded.

Main spans (spans 13-17)

The cast-in-place, reinforced-concrete decks of the main steel girder spans are in satisfactory condition with wear showing on the driving surface and minor hairline cracks and map cracking on the top of deck surface. The underside of the deck exhibits transverse cracks with efflorescence. The main spans of the structure are comprised of a two steel girder system with steel floorbeams and steel stringers. The welded steel plate girders are in good structural condition but the paint system has failed. The areas of the worst failure include the exterior girders (due to exposure from weather), under the finger expansion joints in the deck, at the pin and hanger assemblies, and at the cross frames. The steel stringers are in good structural condition, but the paint system has failed and dirt dauber nests are typical. The steel floorbeams are in good condition, but the paint system has also failed. The pin and hanger assemblies are in satisfactory structural condition, but again the paint system has failed. All eight assemblies exhibit paint failure and active corrosion. The pin and hanger assemblies exhibit good alignment.

The reinforced-concrete piers are in good condition, exhibiting hairline cracks, graffiti, and vegetation growth at the footing. Piers 1 through 6, for the main steel girder spans, have transverse cracks with efflorescence.

The expansion joints in the deck are strip seals that are in good condition with minor failure of the material. The finger joints are in good condition with minor paint system failure. The moveable and fixed bearings are in satisfactory condition. Both exhibit paint system failure and minor spalls on the concrete pads.

The concrete bridge railings and concrete median barrier are in satisfactory condition. The concrete is discolored with exposed aggregate. Additionally, the concrete exhibits hairline cracks with efflorescence and minor surface spalls.

(2) Non-structural observations

The horizontal and vertical geometry of the bridge are good.

The timber fender system is in good condition with no major deficiencies. The mid-section of the south fender exhibits minor deterioration.

The reinforced-concrete approach slabs overlaid with asphalt on both ends of the bridge are exhibiting minor cracking and rutting and wear. The transition from the asphalt approach roadway to the bridge is smooth.

(3) Serviceability observations

The ADT across the bridge is about 28,000 vehicles. The bridge clear roadway width is 28 feet each direction both northbound and southbound, which provides for two lanes of traffic in each direction, with a 1-foot-6-inch sidewalk on the outside of each roadway. The bridge appears to adequately handle this traffic volume.

B. Sources of information

Plans available:	Yes, available at the LADOTD Bridge Section office
Inspection report date:	April 7, 2015
Fracture critical report date:	(included as part of routine inspection report)
Underwater inspection report:	October 20, 2010, with last hydrographic survey June 7, 2014
Date of site visit:	February 4, 2016



Condition Photo 1: Southbound approach, looking south at north end of bridge.



Condition Photo 2: Southbound travel lanes, looking south at south end of bridge.



Condition Photo 3: Approach spans concrete deck slabs, looking north.



Condition Photo 4: Missing bolt at the concrete beam tie down at end bent 1, beam 7.



Condition Photo 5: Dirt dauber nests and water staining at the concrete approach bent caps.



Condition Photo 6: Dirt dauber nests and efflorescence on the underside of the precast prestressed concrete beam approach spans.



Condition Photo 7: Elevation view of concrete bents of the approach spans.



Condition Photo 8: Water staining on the approach span concrete pile bents.



Condition Photo 9: Vines and vegetation growing on the concrete bent pile columns.



Condition Photo 10: Elevation view of the main span (five steel plate girder spans), showing piers 1 and 2, and showing failure of paint system in steel girder spans.



Condition Photo 11: Paint failure of the main span steel girder pin and hanger assembly, typical of all pin and hanger assemblies; also shows failure of paint system on steel girders.



Condition Photo 12: Underside of main spans, steel plate girder paint failure.



Condition Photo 13: Main span, steel plate girder field splice paint failure, typical at all splices.



Condition Photo 14: Underside of joint between the northbound and southbound roadways exhibiting efflorescence and staining on the concrete deck underside.



Condition Photo 15: Paint failure at the steel bearings of the main span, typical for all bearings.



Condition Photo 16: Underside of finger-type expansion joint at the transition from the approach spans to the main span.



Condition Photo 17: West timber fender system.



Condition Photo 18: East timber fender system.

THIS PAGE INTENTIONALLY LEFT BLANK

5. Recommendations

This Preservation Priority Bridge should remain in use and can meet current and projected transportation needs for the next 20 years or more. Maintenance and rehabilitation activities should be completed in a manner consistent with the long-term preservation of this historic bridge. The Statewide Historic Bridge Plan provides additional guidance and approaches to completing maintenance and rehabilitation activities that adhere to the Secretary's Standards. Work should be conducted under the supervision of a qualified professional historian, as defined in the PA. The bridge engineer, or the bridge engineer's supervising engineer, should have demonstrated expertise in historic bridge projects and must have completed the LADOTD's historic bridge training. When developing plans and specifications for a project, the bridge engineer should follow the recommendations below.

Under the terms agreed upon in the PA, the bridge owner may undertake certain activities that are considered to be best practices without additional consultation or public notification. These activities are documented in Attachment 5 of the PA and are limited to the activities specifically noted. All recommended preventative maintenance and rehabilitation activities for this bridge are included in Attachment 5 and are not expected to alter character-defining features or historic fabric of the bridge. Some cyclical or condition-based maintenance items are noted below under Rehabilitation because they are expected to be completed as part of an overall rehabilitation project for this bridge. These activities may need to be completed as conditions dictate to promote long-term preservation of this historic bridge. Recommendations within this Plan should be reviewed in 10 years following completion of the Plan to identify any needed updates or revisions.

The opinions of probable costs provided below are in 2016 dollars. The costs were developed without benefit of preliminary rehabilitation plans and are based on the above identified tasks using engineering judgment and/or gross estimates of quantities and historic unit prices and are intended to provide a programming level of estimated costs. Refinement of the probable costs is recommended once preliminary plans have been developed. The estimated preservation costs include a 10% contingency and 7% mobilization allowance of the preservation activities, excluding soft costs. Actual costs may vary significantly from those opinions of cost provided herein. Engineering design, historical consultation, and construction administration costs are not included as these may be provided by the owner or consultants.

A. Preventative maintenance

The following recommendations are for cyclical maintenance. Because this maintenance is routinely done, its cost is not included in this estimate. There are no condition-based maintenance recommendations at this time, based on the bridge condition as observed during the site visit and as documented in available information.

1. Remove debris from deck and bent caps regularly to maintain good condition, as necessary.
2. Replace timber members missing from the fender protection system to maintain good condition, as necessary.

3. Remove graffiti from concrete substructure units with non-destructive methods, using low-pressure water blast cleaning (no solvents) following testing on a small area.
4. Replace missing anchor bolt nuts at bearing, as needed.

B. Rehabilitation

The following are recommendations for rehabilitation. These activities should be performed when necessary (estimated to be within the next five years):

1. For failed deck joints, remove the failed material and all debris and replace with new material.
2. Clean and paint welded steel plate girder spans, including all bearings, in accordance with the current standard cleaning and painting specification.

Bridge Recall No. 031736				Date:	9/30/2016		
Calcasieu River (Moss Bluff) Bridge							
Opinion of Probable Costs							
Rehabilitation							
Item				Quantity	Unit	Unit Cost	Total
For failed deck joints, remove the failed material and all debris and replace with new material				4,323	LF	\$50	\$216,150
Clean and paint welded steel plate girder spans, including all bearings, in accordance with the current standard cleaning and painting specification				1	LS	\$900,000	\$900,000
Traffic control signage, drums and temporary pavement marking for staged construction of items listed above				1	LS	\$75,000	\$75,000
Item Subtotal							\$1,191,150
Contingency						10.00%	\$119,115
Mobilization						7.00%	\$91,719
TOTAL ESTIMATED CONSTRUCTION COST							\$1,401,984
						Round to:	\$1,402,000

C. Identification of any anticipated design exceptions

No design exceptions were noted, nor are any design exceptions recommended.

Appendix A. Historic Inventory Form

THIS PAGE INTENTIONALLY LEFT BLANK

Louisiana Historic Bridge Inventory

Recall Number: 031736

Structure Number: 07100240103501

SHPO Number: 10-00392

Bridge Name: CALCASIEU R.(MOSS BLUFF)

Location Data:

District: 07

Parish: Calcasieu

Feature Crossed: CALCASIEU RIVER

Facility Carried: US0171

Location: 1.7 MI NORTH OF I-10

City, Village or Town (if applicable): Lake Charles

Status: Open

Bridge Owner: State of Louisiana

Latitude: 30.284472

Longitude: -93.187361

Structural Data:

Bridge Type: Steel Plate Girder

Year Built: 1969

Main Span Configuration (if applicable):

Maximum Span Length (feet): 200

Number of Spans: 77

Overall Structure Length (feet): 5702

Approach Span Type (if applicable): Prestressed concrete stringer/multi-beam or girder

Posted Load:

Current ADT: 029800

Design and Construction Data:

Engineer or Builder:

Unknown

Bridge Plaque:

None

National Register of Historic Places Evaluation:

This steel plate and concrete girder bridge has five main plate girder spans. Two are 150 feet and three are 200 feet, which are considered exceptional main span lengths for steel plate girder bridges. Steel plate girders consist of built-up welded plates with a deep web that lies between the top and bottom flanges, which are fabricated by plate steel placed horizontally over the webs of the girder. The bridge also has a notable overall length of 5,702 feet. The bridge retains good integrity, and despite being a common type conveys exceptional significance and is eligible for listing in the National Register under Criterion C: Design/Engineering.

No evidence was found during research or data collection activities to indicate that this bridge possesses a direct and important association with historical events or trends. This bridge does not possess significance under Criterion A.

Within/Adjacent to Known Historic District: N/A

National Register Historic District Name: N/A

National Register Determination: Eligible

National Register Determination Date: 2013

Surveyor: Mead & Hunt, Inc.

Date Surveyed: 2013



Louisiana Historic Bridge Inventory

Recall Number: 031736

Structure Number: 07100240103501

Bridge Name: CALCASIEU R.(MOSS BLUFF)

Parish: Calcasieu

Bridge Owner: State of Louisiana

Feature Crossed: CALCASIEU RIVER

Facility Carried: US0171

Photographs:



Appendix B. Select Plan Sheets

THIS PAGE INTENTIONALLY LEFT BLANK

150

F	STATE PROJECT	PARISH	SHEET NO.
2170	26-01-16	CALCASIEU	4

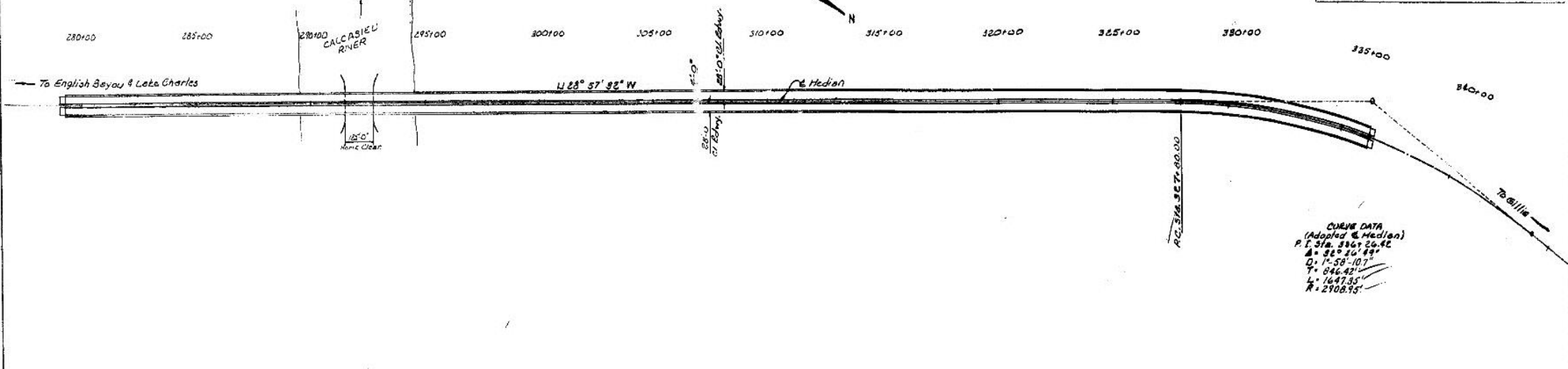

CURVE DATA
 (Adapted to Median)
 P.C. Sta. 336+26.42
 Δ = 32° 20' 49"
 Q = 1'-58'-10.7"
 T = 846.42'
 L = 1647.35'
 R = 2708.75'

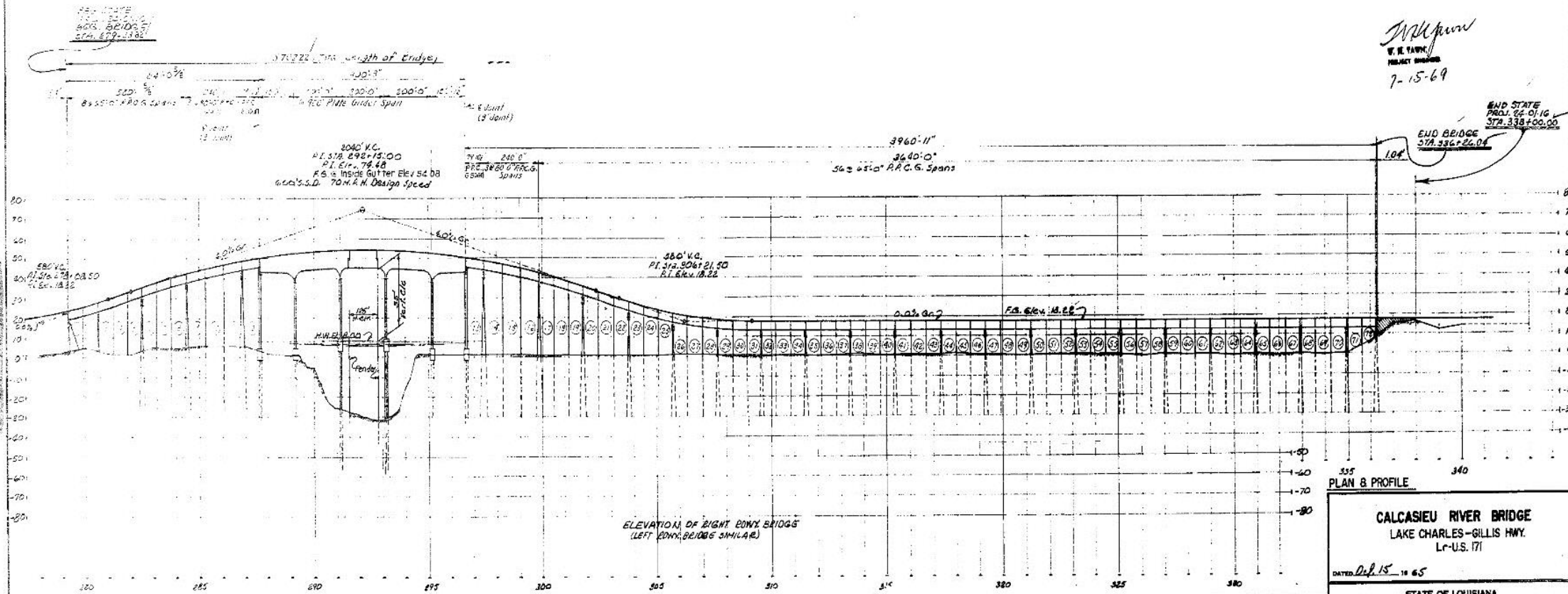

W. K. TAYNOR
 PROJECT ENGINEER
 7-15-69

NOTES:
 Fin. Grade shown is inside gutter.
 All vertical curve data is based on high gutter.

SCALE
 HORIZ. 1" = 80'
 VERT. 1" = 50'

PLAN & PROFILE

CALCASIEU RIVER BRIDGE
 LAKE CHARLES-GILLIS HWY.
 Lr-U.S. 171

DATED *Feb. 15, 1965*

STATE OF LOUISIANA
 DEPARTMENT OF HIGHWAYS

DESIGNED	BY <i>H. H. H. H.</i>	TRACED	BY <i>M. H.</i>
CHECKED	BY <i>H. H. H. H.</i>	CHECKED	BY <i>H. H. H. H.</i>

BRIDGE DESIGN SECTION



151

F	STATE PROJECT	PARISH	SHEET NO.
217 (6)	24-01-16	CALCASIEU	5

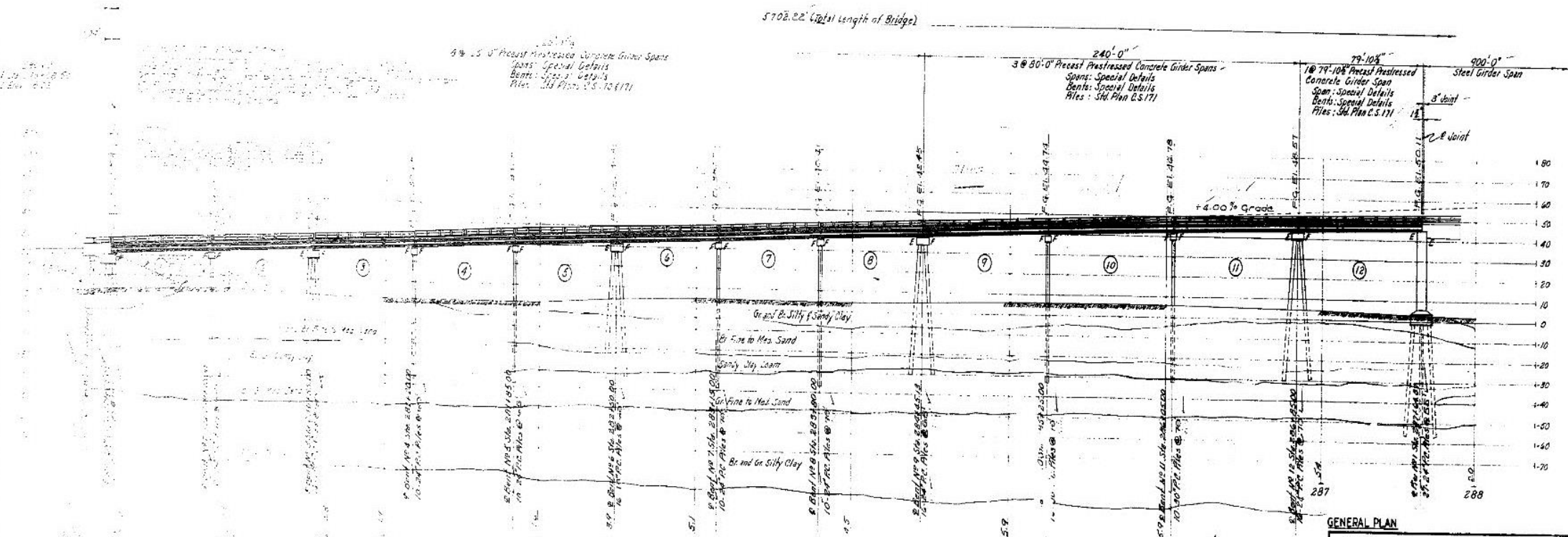
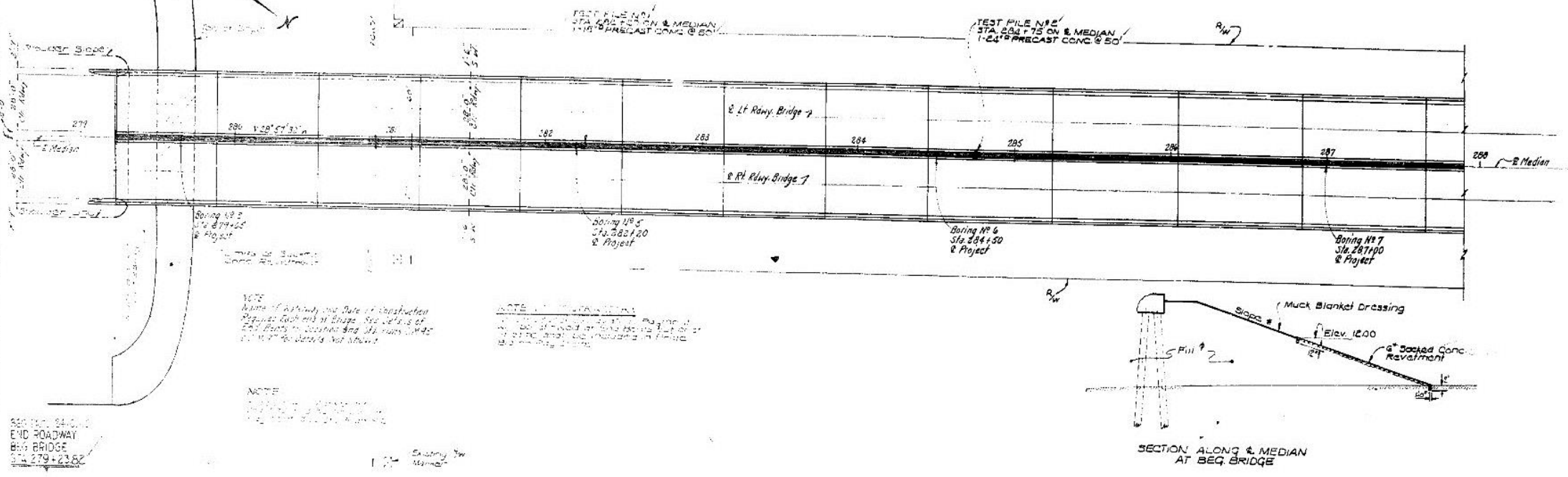

AS BUILT PLANS

NOTE: The bridge is to be constructed on the existing muck blanket as shown on the plan view. The muck blanket is to be placed on top of existing muck blanket as directed by the Engineer.

J. H. Yarn
7-45-69

GENERAL PLAN

CALCASIEU RIVER BRIDGE
LAKE CHARLES - GILLIS HWY
La U.S. 171

DATE: 7-45-69

STATE OF LOUISIANA
DEPARTMENT OF HIGHWAYS

DESIGNED	TRACED
CHECKED	CHECKED

BRIDGE DESIGN SECTION

DATE	DESCRIPTION	BY
5-13-66	R/W	D.S.H.
5-2-66	PILE SITE CHANGE & DET. C.	D.S.H.
5-2-66	1" SLOPED CONC. RELEVANT	D.S.H.



F	STATE PROJECT	PARISH	SHEET NO.
217(8)	26-01-16	CALCASIEU	G

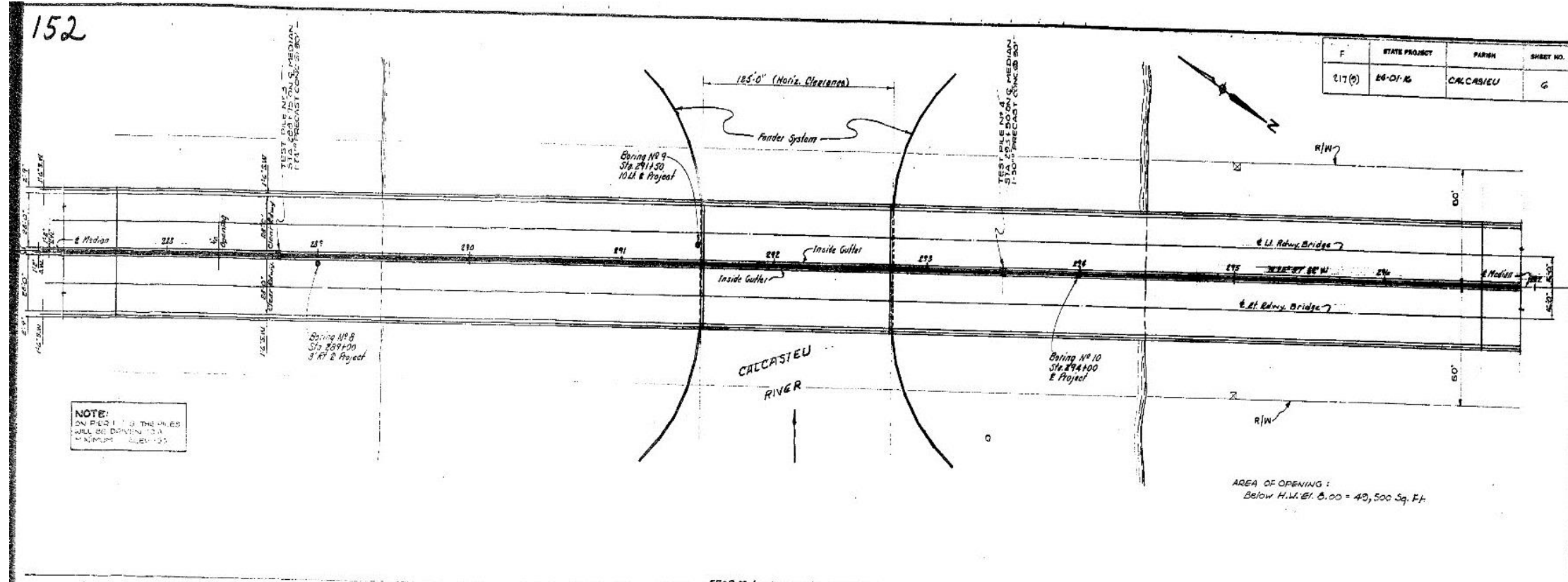

NOTE:
ON P.E. 2 1/2 THE RULES
WILL BE OBSERVED TO A
MINIMUM OF 1/8"

AREA OF OPENING:
Below H.W. Elevation 5.00 = 43,500 Sq. Ft.

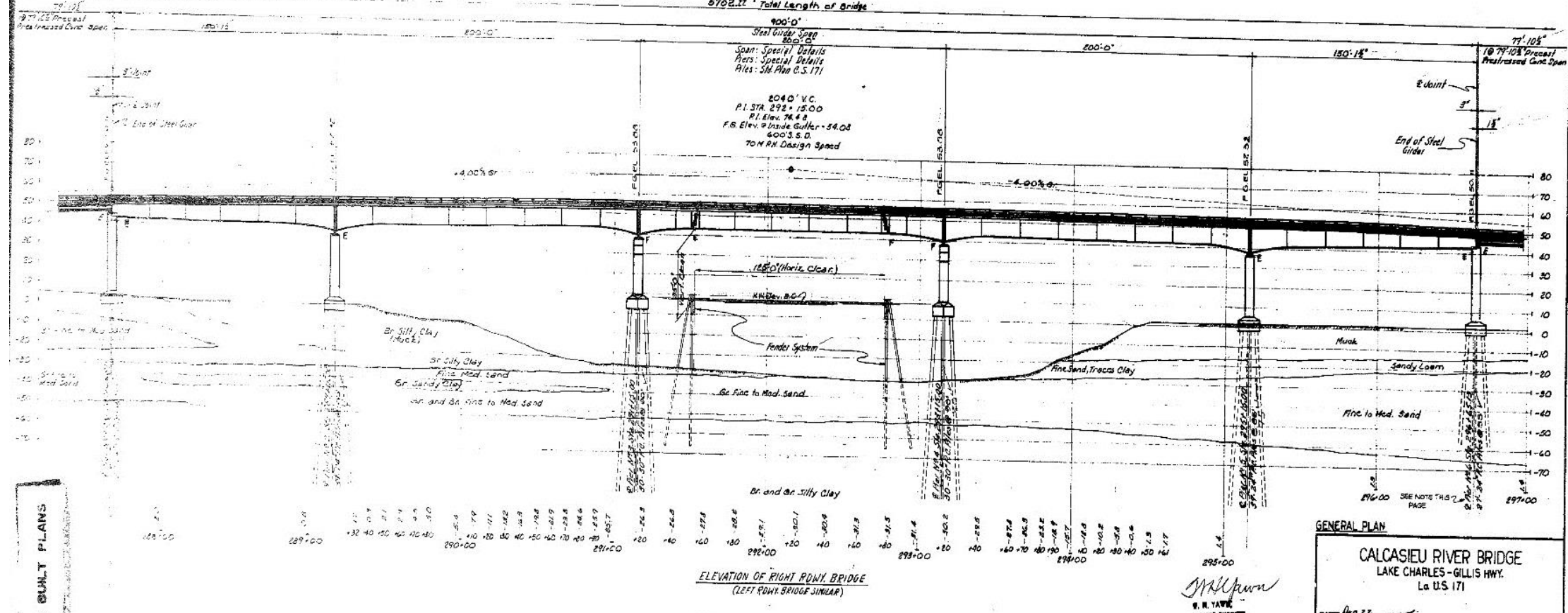

AS SHOWN PLANS

ELEVATION OF RIGHT PONY BRIDGE
(LEFT PONY BRIDGE SIMILAR)

NOTE:
Finish grade elevations are inside gutter @ joint
except as shown. All vertical curve data is based
on inside gutter.

M. H. Yank
S. H. YANK
PROJECT ENGINEER
7-15-69

GENERAL PLAN

CALCASIEU RIVER BRIDGE
LAKE CHARLES - GILLIS HWY.
LA. U.S. 171

DATED: Dec 22, 1965

STATE OF LOUISIANA
DEPARTMENT OF HIGHWAYS

DESIGNED	DETAILED	TRACED
CHECKED	CHECKED	CHECKED

BRIDGE DESIGN SECTION

DATE	DESCRIPTION	BY
5-19-66	R/W	D.S.H.
5-2-66	NOTE	D.S.H.



153

F	STATE PROJECT	PARISH	SHEET NO.
217 (0)	24-01-16	CALCASIEU	7

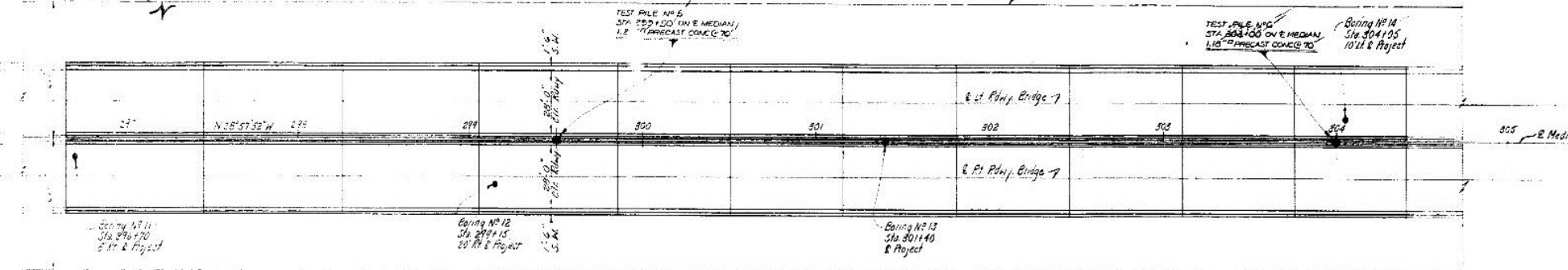

5702.22' (Total Length of Bridge)

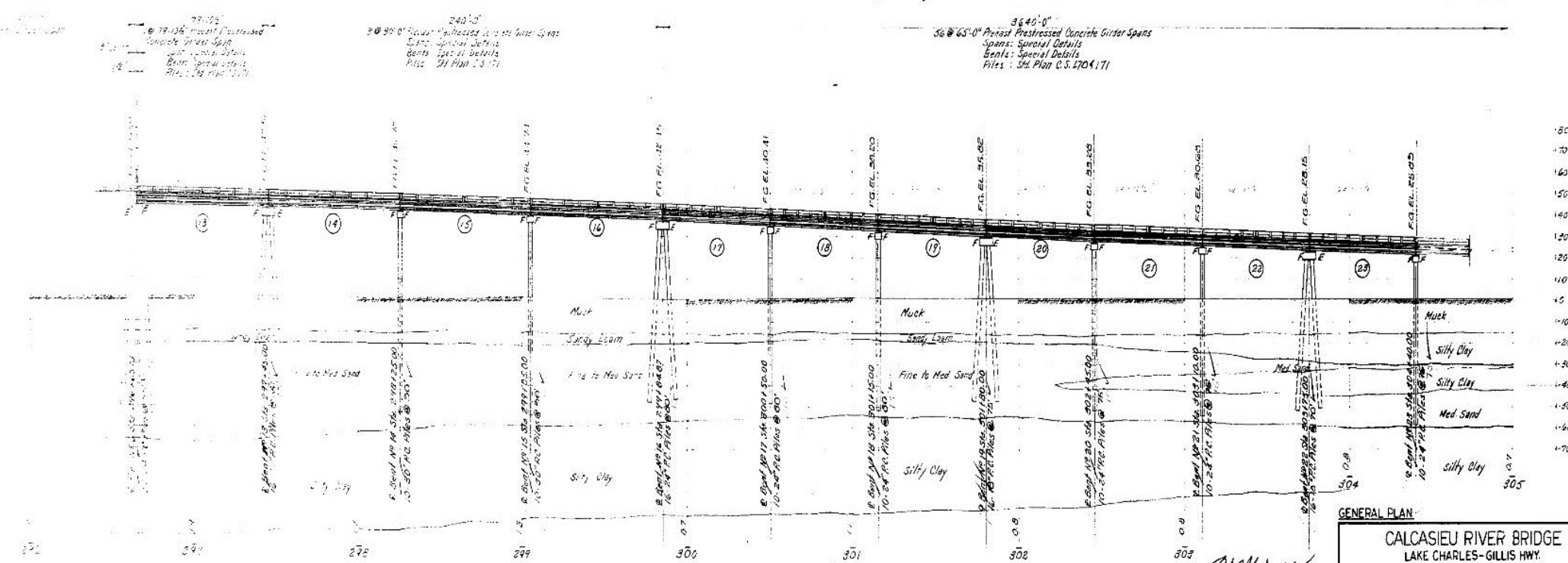

AS BUILT PLANS

D.W. Jawn
 W. H. YARVIS
 PROJECT ENGINEER
 7-15-69

GENERAL PLAN

CALCASIEU RIVER BRIDGE
 LAKE CHARLES-GILLIS HWY.
 La U.S. 171

DATED: MAR 1966

STATE OF LOUISIANA
 DEPARTMENT OF HIGHWAYS

DESIGNED	TRACED
CHECKED	CHECKED
IN CHARGE OF	BRIDGE DESIGN SECTION

NO.	DATE	DESCRIPTION	BY
1	7-15-69	DESIGNED	D.W. JAWN
2		CHECKED	W. H. YARVIS



154

P	STATE PROJECT	PARISH	SHEET NO.
217(2)	24-01-16	CALCASIEU	2

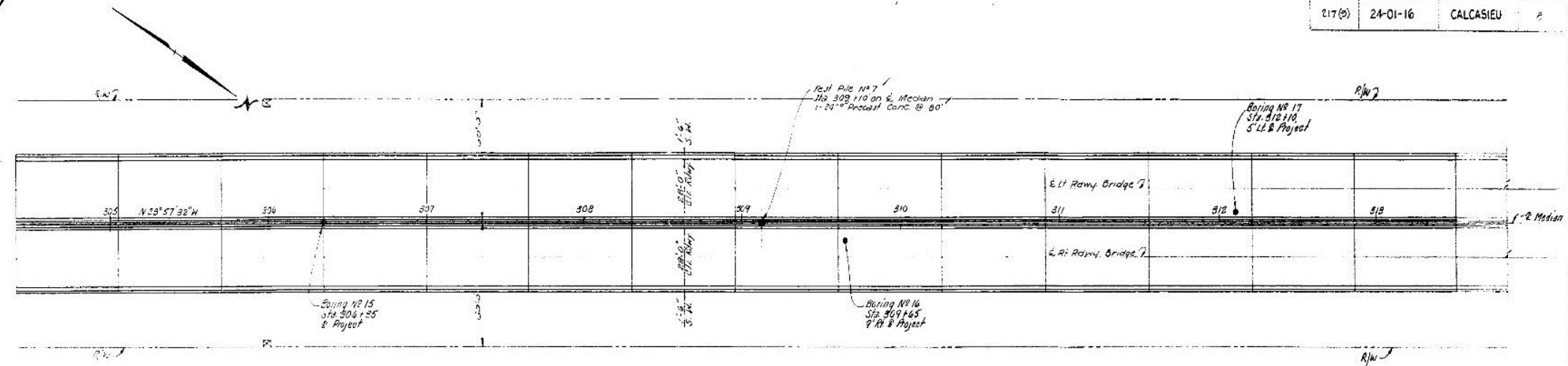

5702.62' (Total Length of Bridge)

3640' 0"
 56 @ 65' 0" Prestressed Concrete Girder Spans
 Spans: Special Details
 Bents: Special Details
 Piles: Std. Plan C.S. 170 & 171

W. K. Yank
 W. K. YANK
 PROJECT ENGINEER
 7-15-69

133' V.C.
 Sta. 306+121.50
 P.I. Elev. 8.22

0.0% Grade
 F.G. Elev. 10.22

AS BUILT PLANS

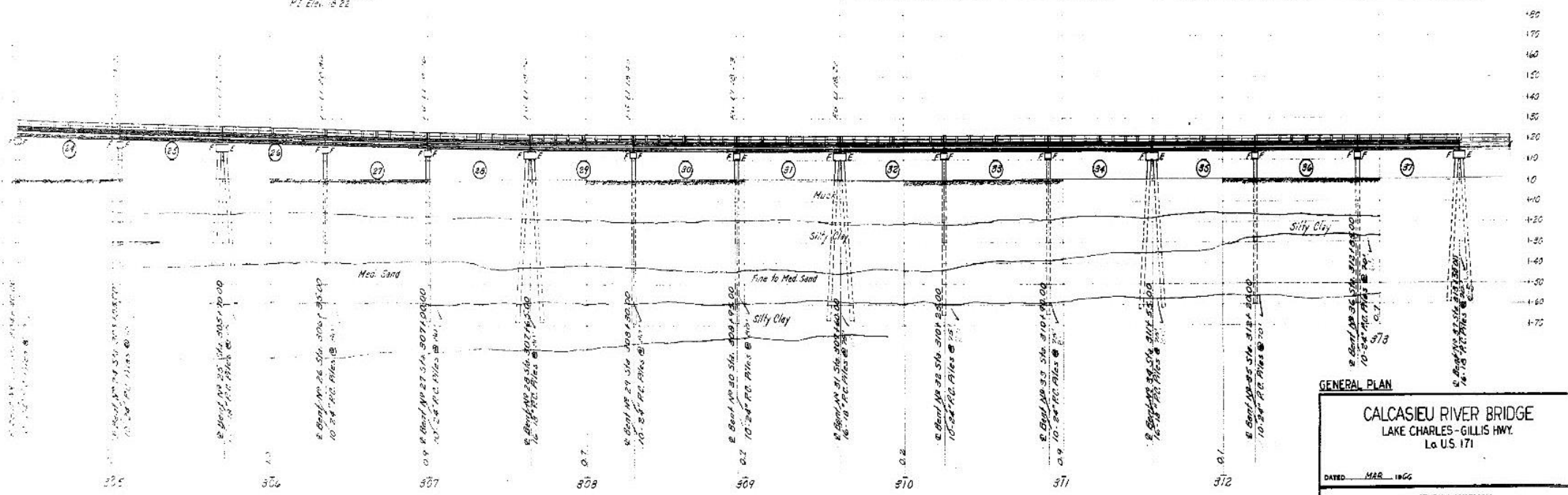

GENERAL PLAN
CALCASIEU RIVER BRIDGE
 LAKE CHARLES - GILLIS HWY.
 La US 171
 DATED: MAR 1966

STATE OF LOUISIANA DEPARTMENT OF HIGHWAYS	
DESIGNED BY: <i>W. K. Yank</i>	TRACED BY: <i>MAT</i>
CHECKED BY: <i>W. K. Yank</i>	CHECKED BY: <i>MAT</i>
IN CHARGE OF: BRIDGE DESIGN SECTION	



F	STATE PROJECT	PARISH	SHEET NO.
217 (5)	24-01-16	CALCASIEU	3

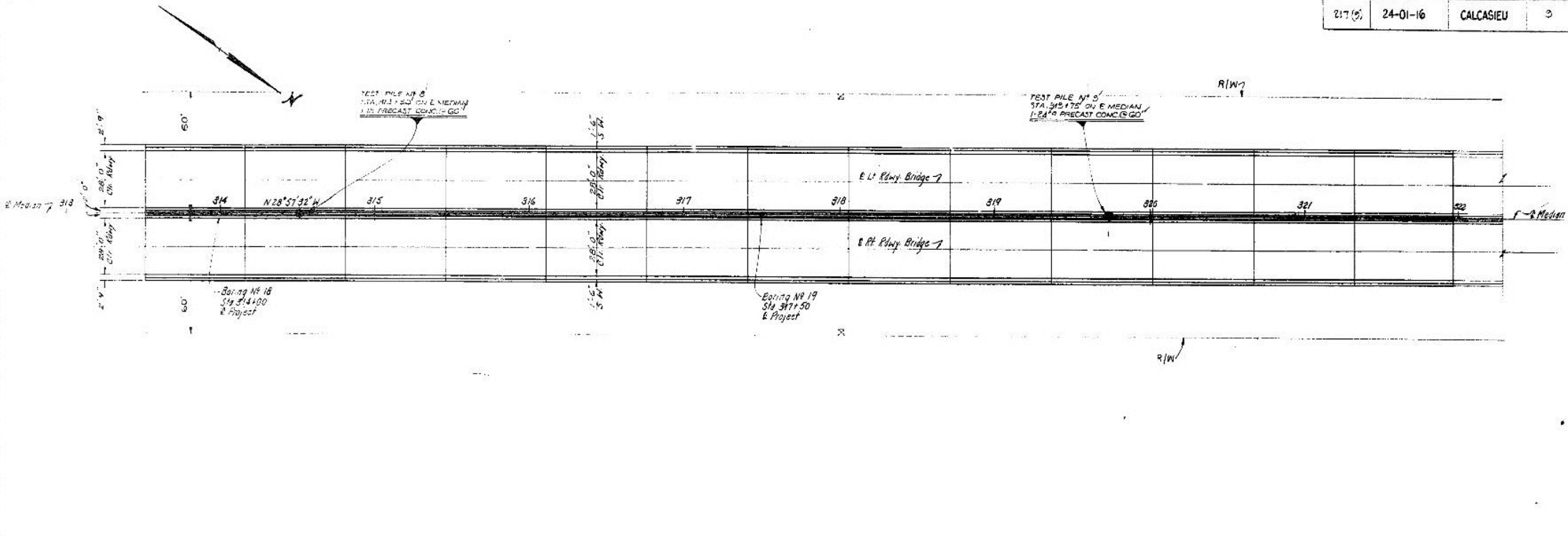

5702.22' (Total Length of Bridge)
 3640'-0"
 36 @ 45'-0" Precast Prestressed Concrete Girders
 Spans: Special Details
 Bents: Special Details
 Piles: 36" Dia. U.S. 170 & 171

W. H. Tamm
 W. H. TAMM
 PROJECT ENGINEER
 7-15-69

AS BUILT PLANS

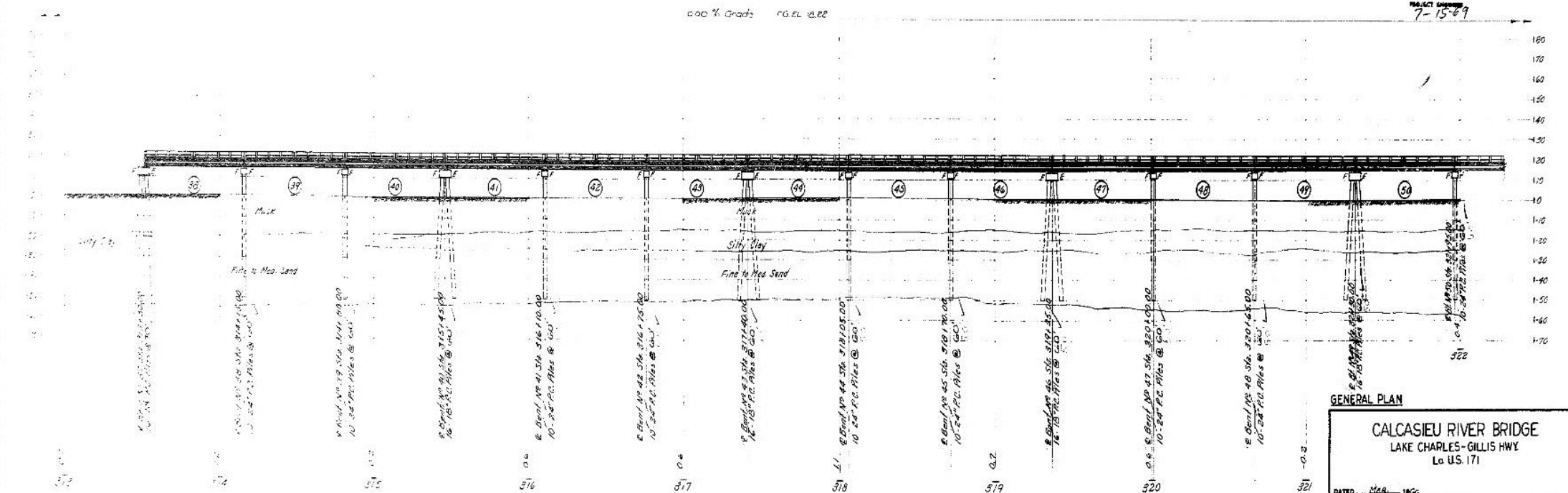

GENERAL PLAN
CALCASIEU RIVER BRIDGE
 LAKE CHARLES-GILLIS HWY
 La. U.S. 171
 DATED: MAR. 1969

DESIGNED	BY	DATE	DESCRIPTION	REVISIONS
CHECKED	BY			
IN CHARGE OF				

STATE OF LOUISIANA DEPARTMENT OF HIGHWAYS		
DESIGNED	BY	DATE
CHECKED	BY	
IN CHARGE OF		



156

F	STATE PROJECT	PARISH	SHEET NO.
217 (9)	24-01-16	CALCASIEU	10

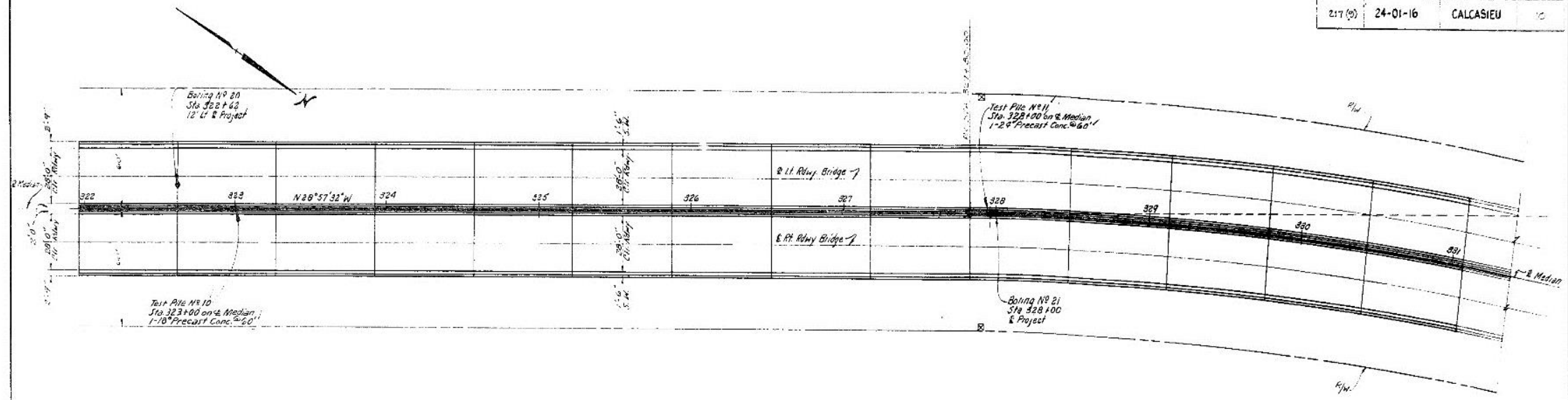

5702.22 (Total Length of Bridge)

3648'-0"
 36 @ 25'-0" Prestressed Concrete Girders Spans
 Spans: Special Details
 Bents: Special Details
 Piles: Std. Plan C.S. 170 & 171

0.00% Grade F.G. Elev. 18.22

W. R. Yarn
 W. R. YARN
 PROJECT ENGINEER
 7-15-69

AS BUILT PLANS

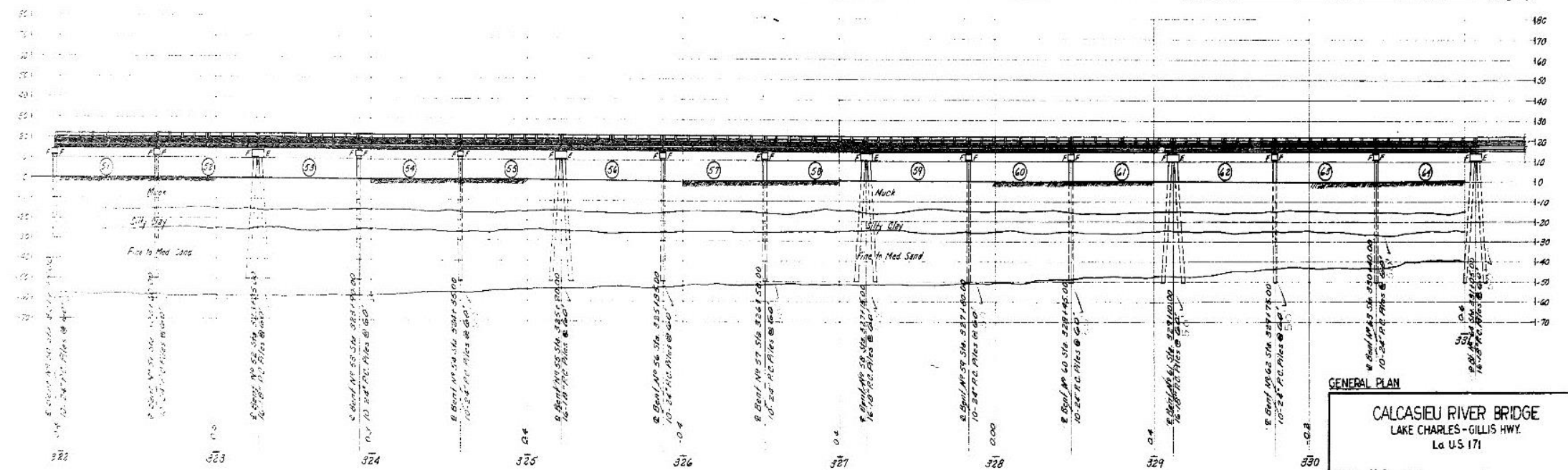

GENERAL PLAN
CALCASIEU RIVER BRIDGE
 LAKE CHARLES - GILLIS HWY.
 La US 171
 DATED MAR 1966

DESIGNED	BY	DATE	DESCRIPTION	REVISIONS
CHECKED	BY	DATE	DESCRIPTION	REVISIONS

STATE OF LOUISIANA
 DEPARTMENT OF HIGHWAYS
 BRIDGE DESIGN SECTION



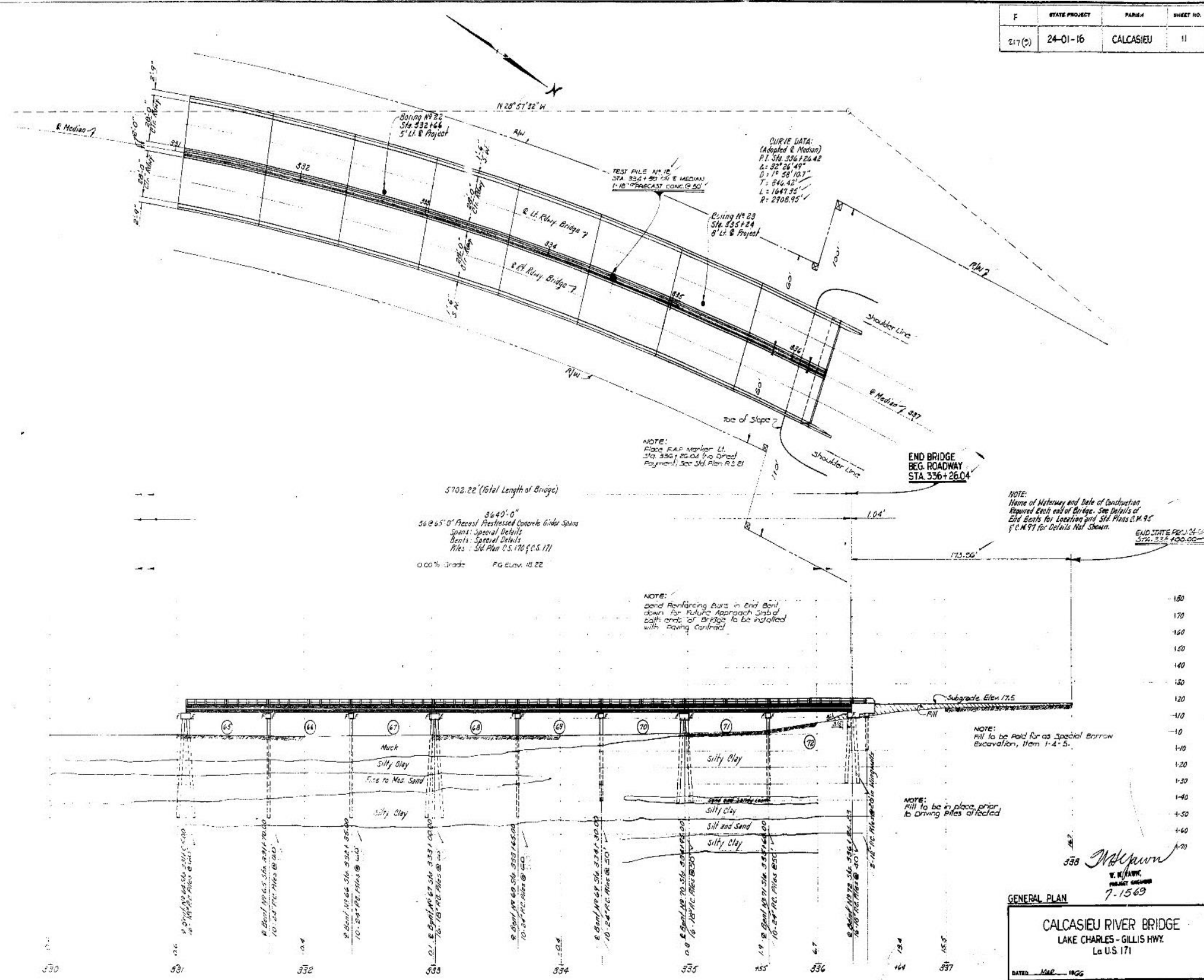

5702.22' (Total Length of Bridge)
 3640'-0"
 36 @ 45'-0" Prestress. Prestressed Concrete Girder Spans
 Spans: Special Details
 Bents: Special Details
 Piles: Std. Plan C.S. 170 & C.S. 171
 0.00% Grade PG. Elev. 18.22

CURVE DATA:
 (Adopted @ Median)
 P.I. STA. 336+26.42
 L = 227.26' / 49°
 D = 1° 28' 10.7"
 T = 846.42'
 L = 1647.32'
 R = 2708.95'

NOTE:
 Place F.A.P. Marker Lt.
 Sta. 336+18.04 for Overt
 Payment. See Std. Plan R.S. 21

NOTE:
 Name of Motorway and Date of Construction
 Required Each end of Bridge. See Details of
 End Bents for Location and Std. Plans C.S. 95
 & C.S. 97 for Details Not Shown.

NOTE:
 Bond Reinforcing Bars in End Bents
 down for future Approach Slab at
 both ends of Bridge to be installed
 with paving contract

NOTE:
 Fill to be in place prior
 to driving piles affected

338 *McKinnon*
 V. K. HANCOCK
 PROJECT ENGINEER
 7-15-69

GENERAL PLAN
CALCASIEU RIVER BRIDGE
 LAKE CHARLES - GILLIS HWY.
 La U.S. 171
 DATED: MAR - 1966

DESIGNED	BY	DATE	DESCRIPTION	BY	DATE
CHECKED					
IN CHARGE OF	BRIDGE DESIGN SECTION				

AS BUILT PLANS



F	STATE PROJECT	PARISH	SHEET NO.
217 (B)	28 01 16	CALCASIEU	22

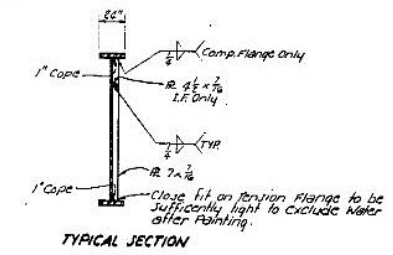
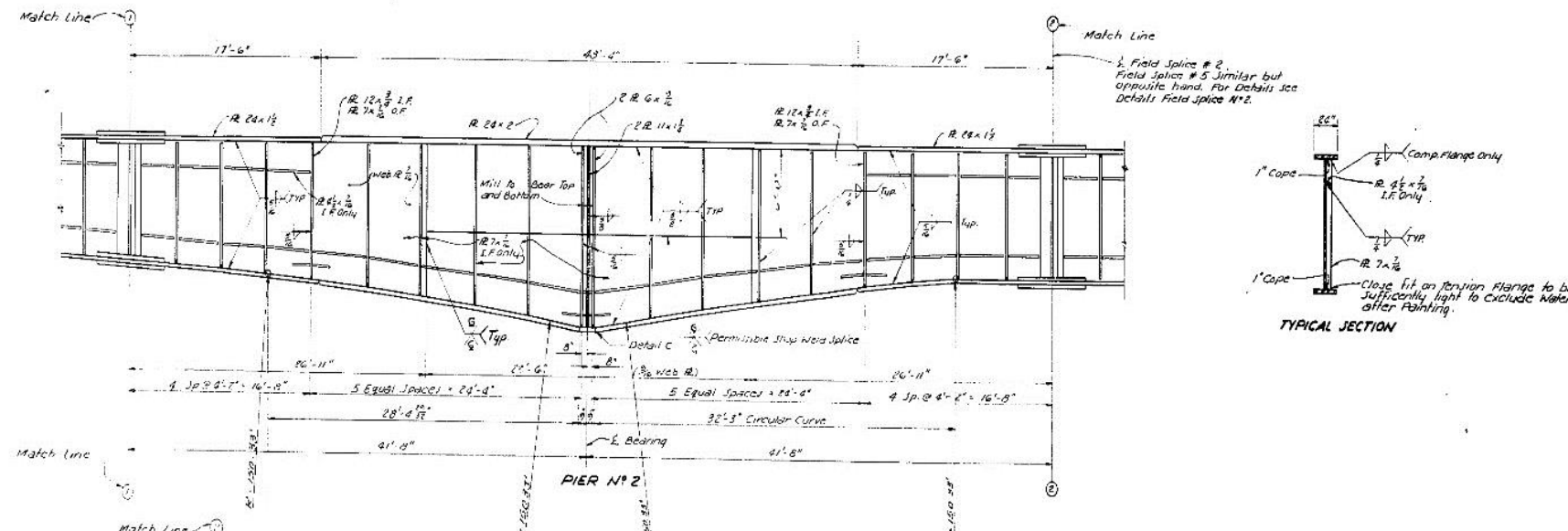
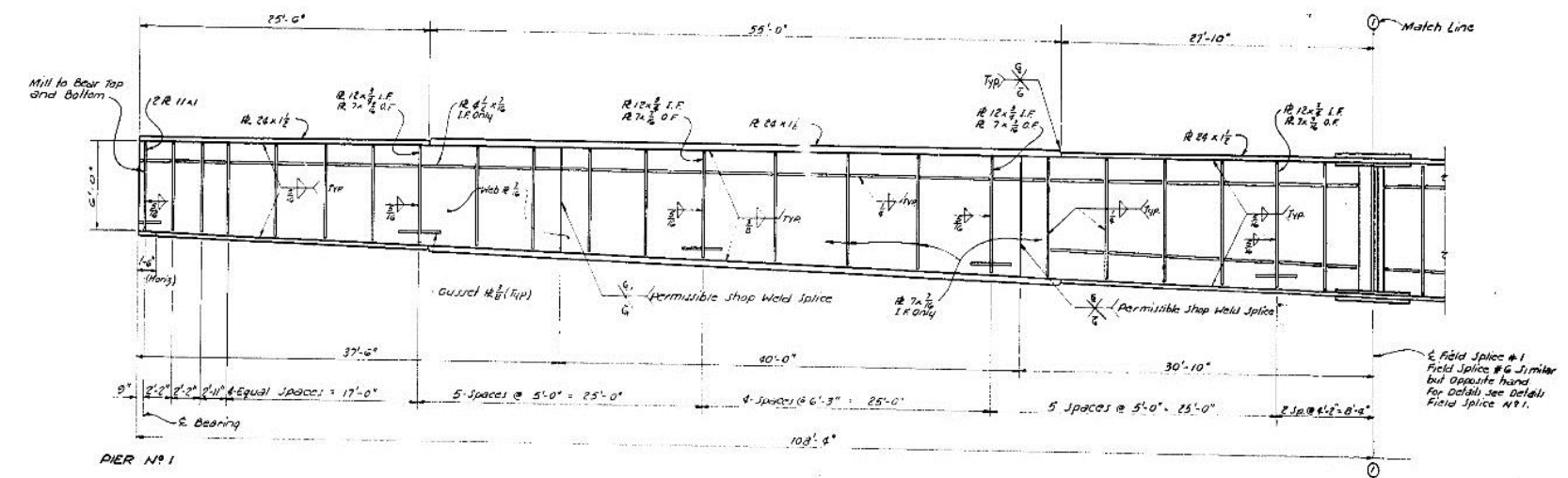

NOTE:
All stiffener and floorbeams are set normal to Profile Grade.

AS BUILT PLANS

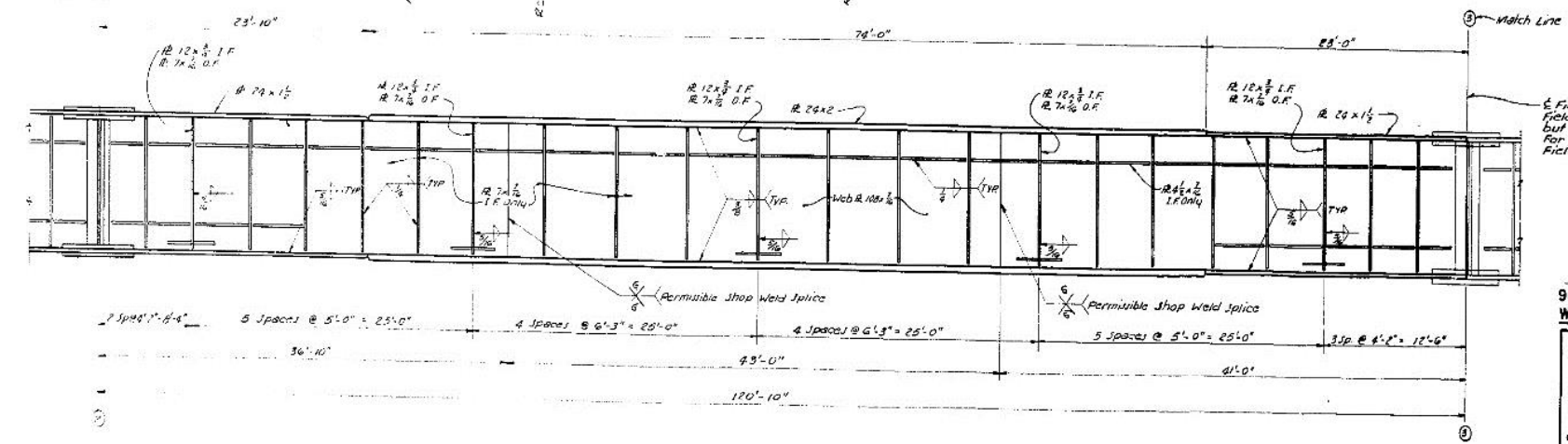

M. H. Yank
M. H. YANK
PROJ. ENGINEER
7-15-69

900' STEEL GIRDER SPAN
WELED PLATE GIRDER

CALCASIEU RIVER BRIDGE
LAKE CHARLES-GILLS HWY.
LA - U.S. 171
DATED Jan 7 1966

STATE OF LOUISIANA DEPARTMENT OF HIGHWAYS		
DESIGNED <i>H. J. ...</i>	DETAILED <i>R. ...</i>	TRACED <i>R. ...</i>
CHECKED <i>R. ...</i>	CHECKED <i>D. ...</i>	CHECKED <i>H. ...</i>
BRIDGE DESIGN SECTION		



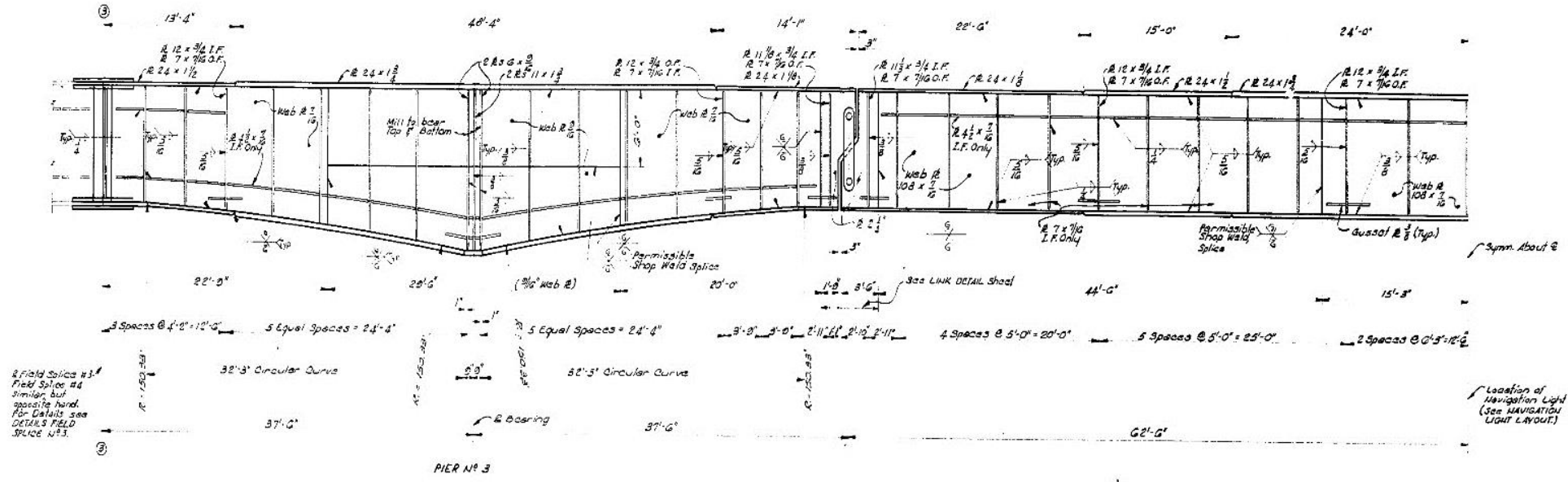

X (FT)	D	d
0.000	0'-0"	1'-8 1/2"
3.750	0'-0"	1'-2 1/2"
7.500	0'-0"	1'-2 1/2"
11.250	0'-1 1/2"	1'-2 1/2"
15.000	0'-2"	1'-2 1/2"
18.750	0'-3"	1'-2 1/2"
22.500	0'-4"	1'-2 1/2"
26.250	0'-5"	1'-2 1/2"
30.000	0'-6"	1'-2 1/2"
33.750	0'-7"	1'-2 1/2"
37.500	0'-8"	1'-2 1/2"
41.250	0'-9"	1'-2 1/2"
45.000	0'-10"	1'-2 1/2"
48.750	0'-11"	1'-2 1/2"
52.500	0'-12"	1'-2 1/2"
56.250	1'-0"	1'-2 1/2"
60.000	1'-1"	1'-2 1/2"
63.750	1'-2"	1'-2 1/2"
67.500	1'-3"	1'-2 1/2"
71.250	1'-4"	1'-2 1/2"
75.000	1'-5"	1'-2 1/2"
78.750	1'-6"	1'-2 1/2"
82.500	1'-7"	1'-2 1/2"
86.250	1'-8"	1'-2 1/2"
90.000	1'-9"	1'-2 1/2"
93.750	1'-10"	1'-2 1/2"
97.500	1'-11"	1'-2 1/2"
101.250	2'-0"	1'-2 1/2"
105.000	2'-1"	1'-2 1/2"
108.750	2'-2"	1'-2 1/2"
112.500	2'-3"	1'-2 1/2"
116.250	2'-4"	1'-2 1/2"
120.000	2'-5"	1'-2 1/2"
123.750	2'-6"	1'-2 1/2"
127.500	2'-7"	1'-2 1/2"
131.250	2'-8"	1'-2 1/2"
135.000	2'-9"	1'-2 1/2"
138.750	2'-10"	1'-2 1/2"
142.500	2'-11"	1'-2 1/2"
146.250	3'-0"	1'-2 1/2"
150.000	3'-1"	1'-2 1/2"

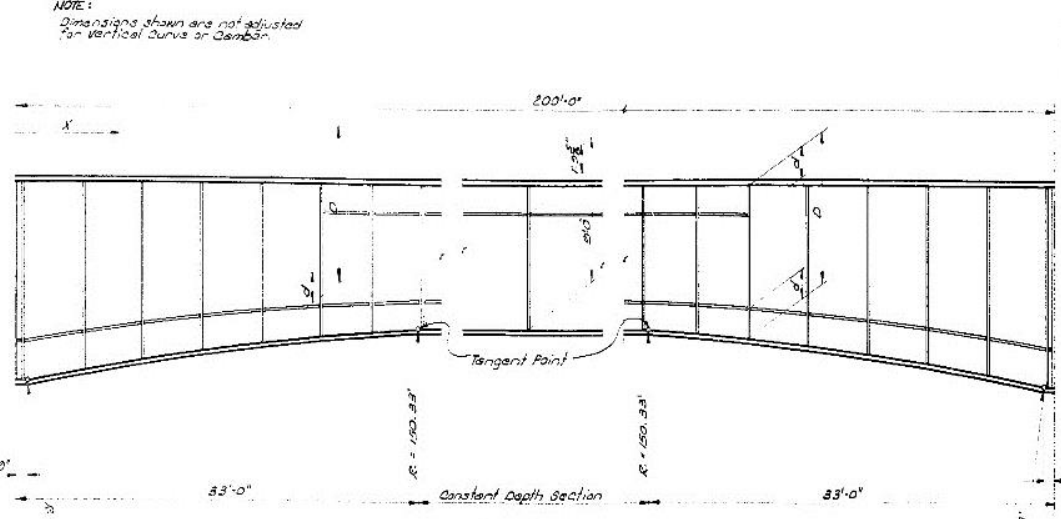
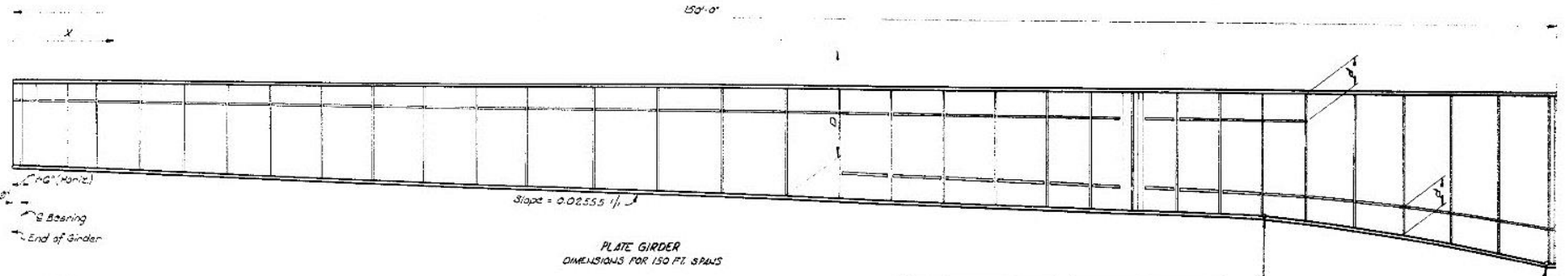

X (FT)	D	d
0.000	12'-6"	2'-6"
0.627	12'-6"	2'-6"
5.524	11'-6"	2'-3 1/2"
10.420	10'-6"	2'-1 1/2"
15.317	10'-0"	2'-0 1/2"
20.213	9'-6"	1'-10 1/2"
25.110	9'-2"	1'-10 1/2"
30.006	9'-0"	1'-8 1/2"
34.902	9'-0"	1'-6 1/2"
39.798	9'-0"	1'-4 1/2"
44.694	9'-0"	1'-2 1/2"
49.590	9'-0"	1'-0 1/2"
54.486	9'-0"	1'-0 1/2"
59.382	9'-0"	1'-0 1/2"
64.278	9'-0"	1'-0 1/2"
69.174	9'-0"	1'-0 1/2"
74.070	9'-0"	1'-0 1/2"
78.966	9'-0"	1'-0 1/2"
83.862	9'-0"	1'-0 1/2"
88.758	9'-0"	1'-0 1/2"
93.654	9'-0"	1'-0 1/2"
98.550	9'-0"	1'-0 1/2"
103.446	9'-0"	1'-0 1/2"
108.342	9'-0"	1'-0 1/2"
113.238	9'-0"	1'-0 1/2"
118.134	9'-0"	1'-0 1/2"
123.030	9'-0"	1'-0 1/2"
127.926	9'-0"	1'-0 1/2"
132.822	9'-0"	1'-0 1/2"
137.718	9'-0"	1'-0 1/2"
142.614	9'-0"	1'-0 1/2"
147.510	9'-0"	1'-0 1/2"
152.406	9'-0"	1'-0 1/2"
157.302	9'-0"	1'-0 1/2"
162.198	9'-0"	1'-0 1/2"
167.094	9'-0"	1'-0 1/2"
171.990	9'-0"	1'-0 1/2"
176.886	9'-0"	1'-0 1/2"
181.782	9'-0"	1'-0 1/2"
186.678	9'-0"	1'-0 1/2"
191.574	9'-0"	1'-0 1/2"
196.470	9'-0"	1'-0 1/2"
201.366	9'-0"	1'-0 1/2"
206.262	9'-0"	1'-0 1/2"
211.158	9'-0"	1'-0 1/2"
216.054	9'-0"	1'-0 1/2"
220.950	9'-0"	1'-0 1/2"
225.846	9'-0"	1'-0 1/2"
230.742	9'-0"	1'-0 1/2"
235.638	9'-0"	1'-0 1/2"
240.534	9'-0"	1'-0 1/2"
245.430	9'-0"	1'-0 1/2"
250.326	9'-0"	1'-0 1/2"
255.222	9'-0"	1'-0 1/2"
260.118	9'-0"	1'-0 1/2"
265.014	9'-0"	1'-0 1/2"
269.910	9'-0"	1'-0 1/2"
274.806	9'-0"	1'-0 1/2"
279.702	9'-0"	1'-0 1/2"
284.598	9'-0"	1'-0 1/2"
289.494	9'-0"	1'-0 1/2"
294.390	9'-0"	1'-0 1/2"
299.286	9'-0"	1'-0 1/2"
304.182	9'-0"	1'-0 1/2"
309.078	9'-0"	1'-0 1/2"
313.974	9'-0"	1'-0 1/2"
318.870	9'-0"	1'-0 1/2"
323.766	9'-0"	1'-0 1/2"
328.662	9'-0"	1'-0 1/2"
333.558	9'-0"	1'-0 1/2"
338.454	9'-0"	1'-0 1/2"
343.350	9'-0"	1'-0 1/2"
348.246	9'-0"	1'-0 1/2"
353.142	9'-0"	1'-0 1/2"
358.038	9'-0"	1'-0 1/2"
362.934	9'-0"	1'-0 1/2"
367.830	9'-0"	1'-0 1/2"
372.726	9'-0"	1'-0 1/2"
377.622	9'-0"	1'-0 1/2"
382.518	9'-0"	1'-0 1/2"
387.414	9'-0"	1'-0 1/2"
392.310	9'-0"	1'-0 1/2"
397.206	9'-0"	1'-0 1/2"
402.102	9'-0"	1'-0 1/2"
407.000	9'-0"	1'-0 1/2"

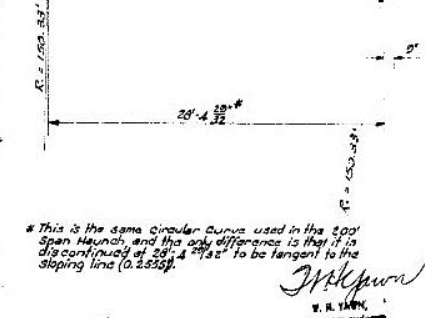

900 STEEL GIRDER SPAN
WELDED PLATE GIRDER

W. H. YAM, PROJECT ENGINEER
7-15-67

STATE OF LOUISIANA
DEPARTMENT OF HIGHWAYS

DESIGNED: H. H. H. / D.S.H.
CHECKED: E. B. G. / D.S.H.

TRACED: M. H. H. / D.S.H.
CHECKED: D. H. H. / D.S.H.

BRIDGE DESIGN SECTION



AS BUILT PLANS

177

F	STATE PROJECT	PARISH	SHEET NO.
217 (B)	24-01-16	CALCASIEU	30

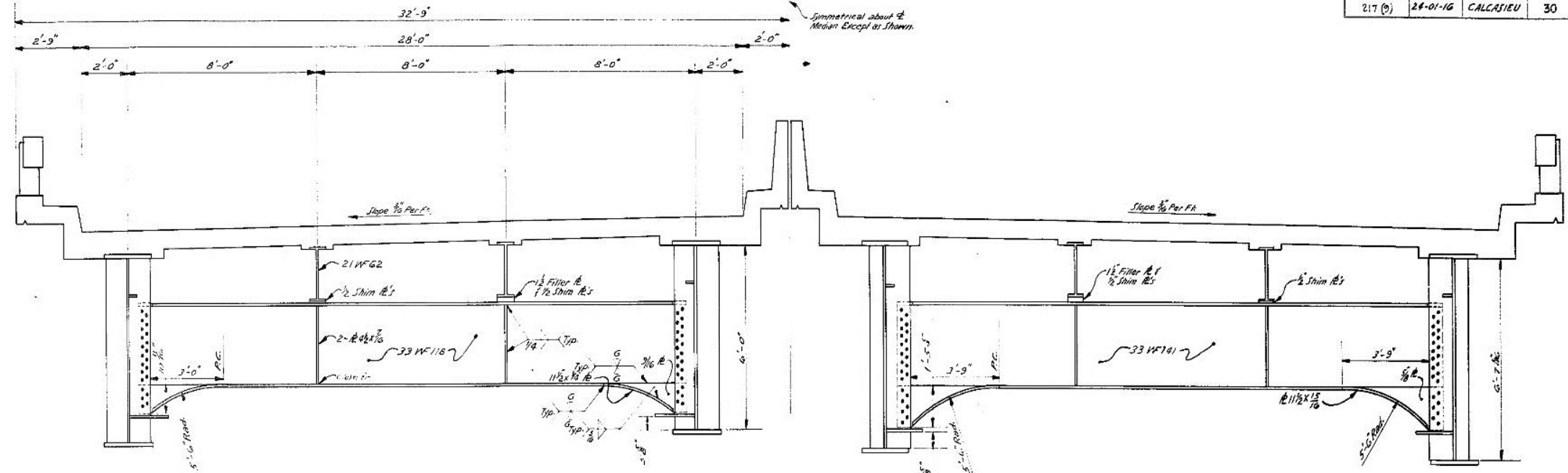

HALF SECTION AT FLOORBEAM FB-1

HALF SECTION AT FLOORBEAM FB-2

NOTE:
Details not shown are same
As at Floorbeam FB-1

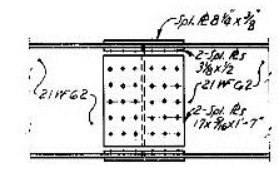
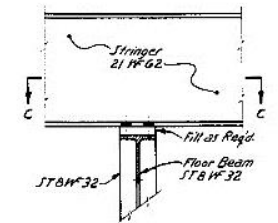
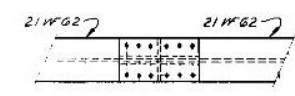

STRINGER SPLICE

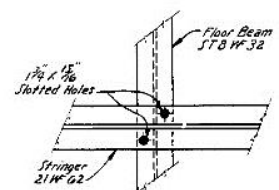

SECTION C-C
STRINGER CONNECTIONS AT FLOOR BEAMS

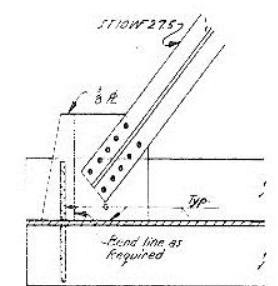

DETAIL A
(FB-1)

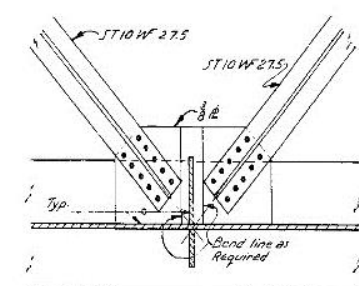

DETAIL B
(FB-2)

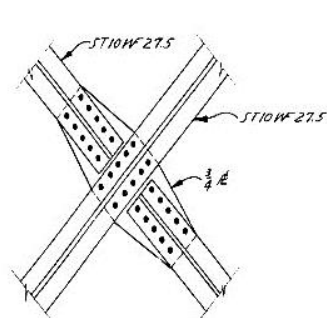

DETAIL C

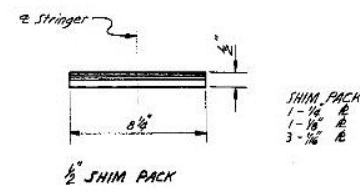

SHIM PACK
1 - 1/2" B
1 - 1/2" B
3 - 1/2" B

M. H. HAY
M. H. HAY, P.E.
PROJECT ENGINEER
7-15-69

900' STEEL GIRDER SPAN
DETAILS OF FLOORBEAM FB-1 AND FB-2
AND LATERAL CONNECTIONS

CALCASIEU RIVER BRIDGE
LAKE CHARLES-GILLIS HWY.
La.-U.S. 171

DATED JAN. 10, 1966

STATE OF LOUISIANA
DEPARTMENT OF HIGHWAYS

DESIGNED <i>D. Hays</i>	DETAILED <i>D. Hays</i>	TRACED <i>R. Hays</i>
CHECKED <i>R. Sisco</i>	CHECKED <i>R. Sisco</i>	CHECKED <i>D. Hays</i>
DATE	DESCRIPTION	BY
	REVISIONS	

BRIDGE DESIGN SECTION
SHEET 5 of 12

AS BUILT PLANS



178

F	STATE PROJECT	PARISH	SHEET NO.
2173	24-01-16	CALCASIEU	31

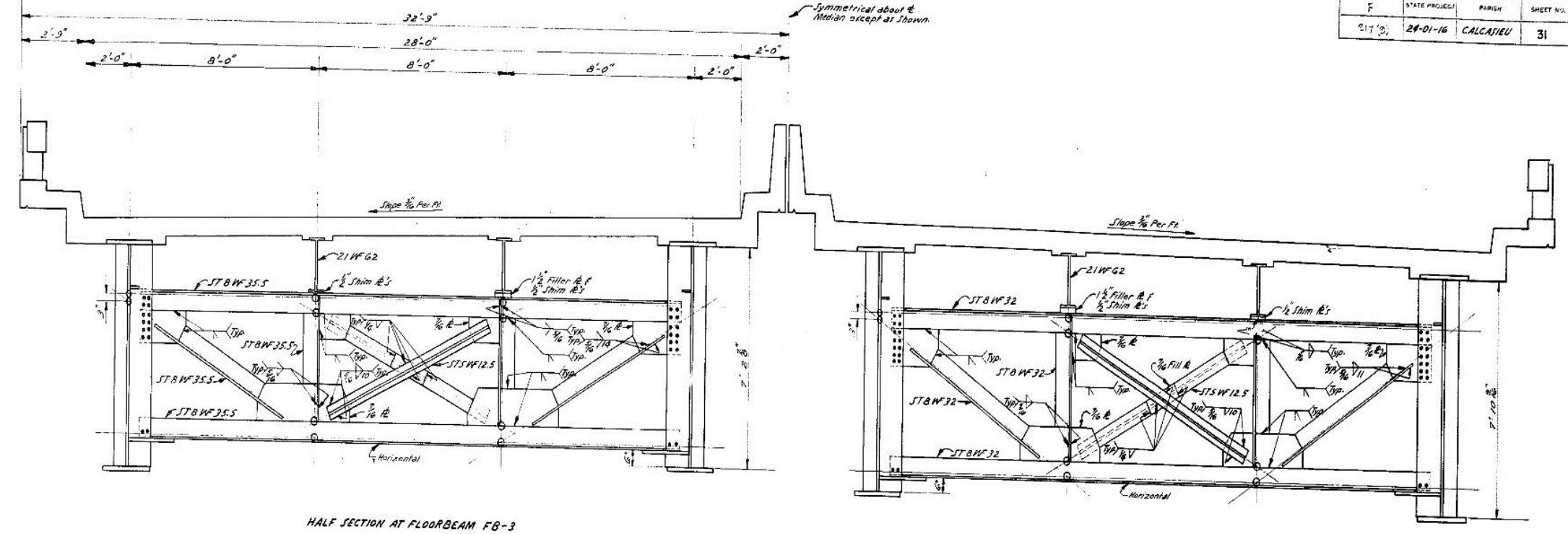

HALF SECTION AT FLOORBEAM FB-3

HALF SECTION AT FLOORBEAM FB-4

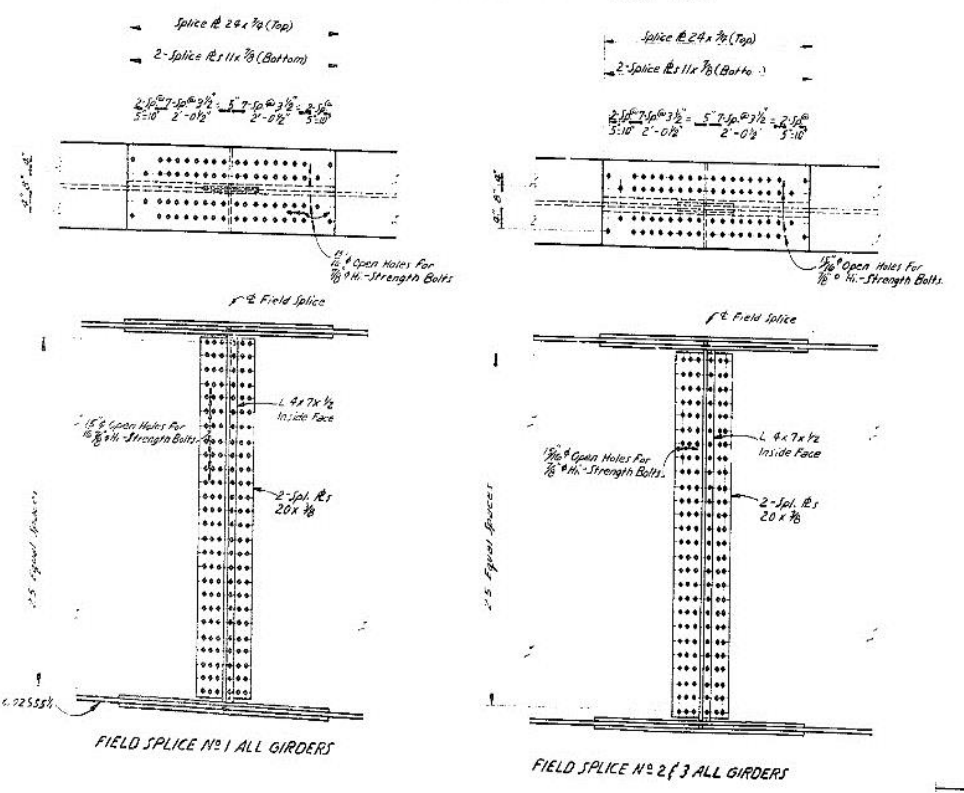

FIELD SPLICE NO. 1 ALL GIRDERS

FIELD SPLICE NO. 2 OF 3 ALL GIRDERS

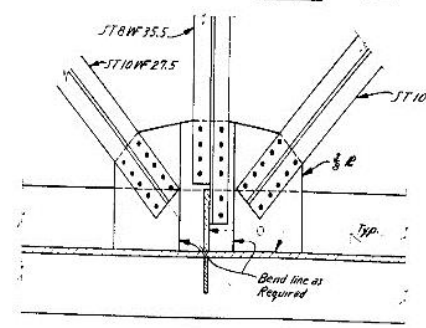

DETAIL D (FB-3)

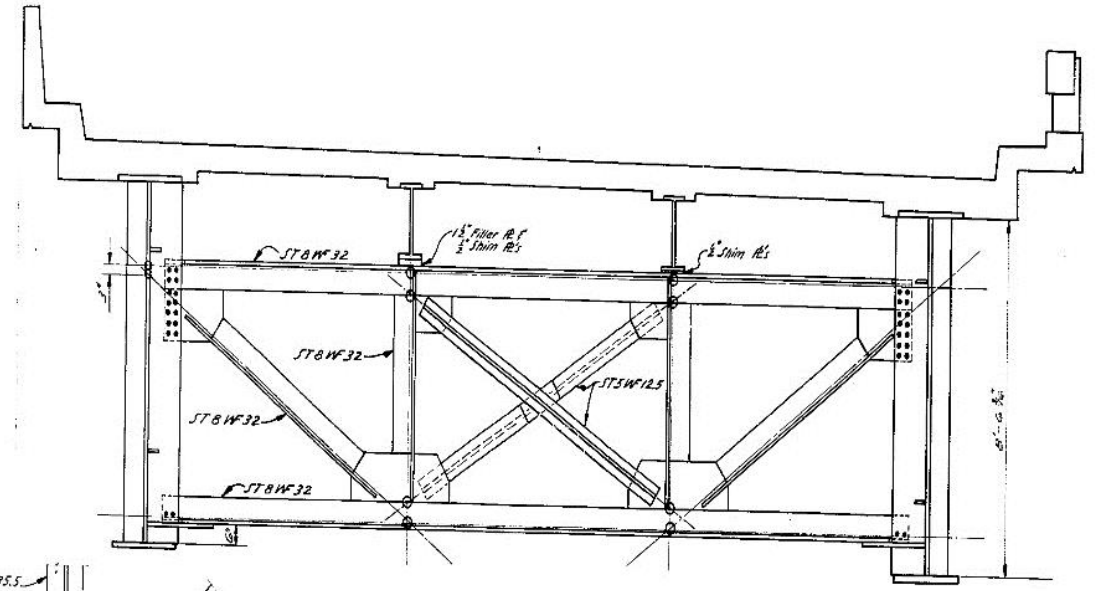

HALF SECTION AT FLOORBEAM FB-5

NOTE: Details not shown are same as at Floorbeam FB-4.

900' STEEL GIRDER SPAN
DETAILS OF FLOORBEAM FB-3 TO FB-5
AND LATERAL CONNECTION AND FIELD SPLICES

CALCASIEU RIVER BRIDGE
LAKE CHARLES-GILLIS HWY.
LA-U.S.171

STATE OF LOUISIANA
DEPARTMENT OF HIGHWAYS

W. K. TAYLOR
PROJECT ENGINEER
7-15-69

DESIGNED	D. Havel	DETAILED	D. Havel	TRACED	G. Havel
CHECKED	R. J. Sarno	CHECKED	R. J. Sarno	CHECKED	D. Havel
DATE		REVISIONS			



AS BUILT PLANS

F	STATE PROJECT	PARISH	SHEET NO.
2:7 (5)	26 01 16	CALCASEU	32

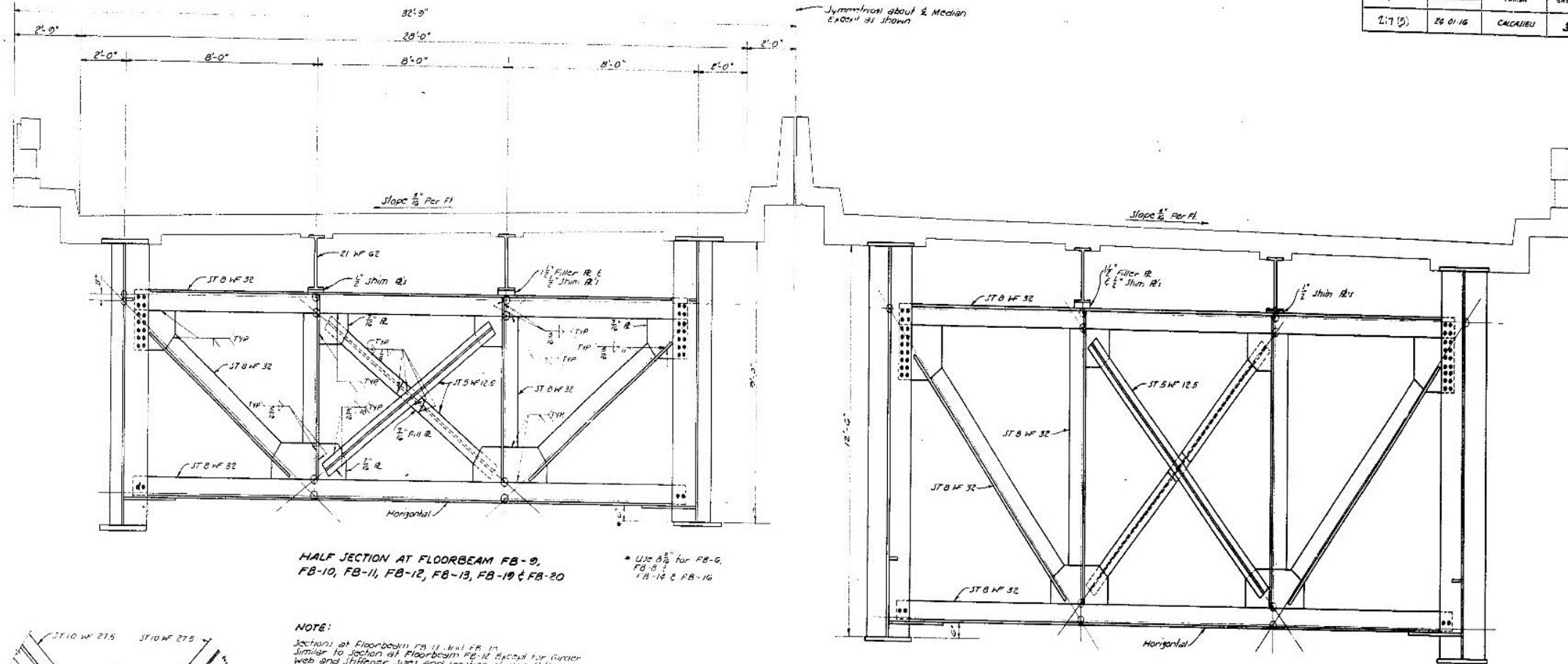

HALF SECTION AT FLOORBEAM FB-9, FB-10, FB-11, FB-12, FB-13, FB-19 & FB-20
* Use A 3/8" for FB-6, FB-8, FB-14 & FB-16

HALF SECTION AT FLOORBEAM FB-7, FB-15
NOTE: Details not shown are same as at Floorbeam FB-12.

NOTE:
Section at Floorbeam FB-11 and FB-12 similar to section at Floorbeam FB-12 except for Gutter Web and Stiffener size and location of new stiffener.
Section at Floorbeam FB-6, FB-8, FB-14 and FB-16 are similar to section at Floorbeam FB-9 except for location of new stiffener and Girder Depth which changes the width of Flange to center of Floorbeam Distance to B₂.
Section at Floorbeam FB-19 is similar to section at Floorbeam FB-9 except for location of new stiffener and Girder Depth which changes the width of Flange to center of Floorbeam Distance to B₂ and Gasket Plate (shown in detail H) not shown.

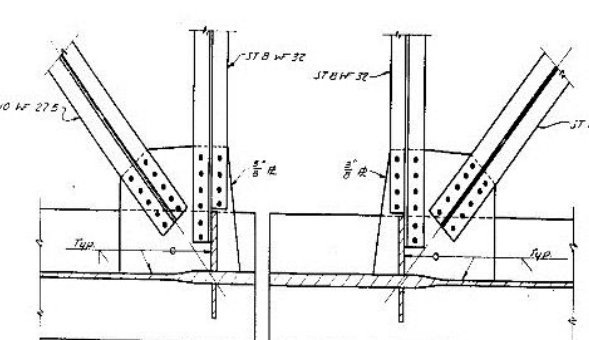
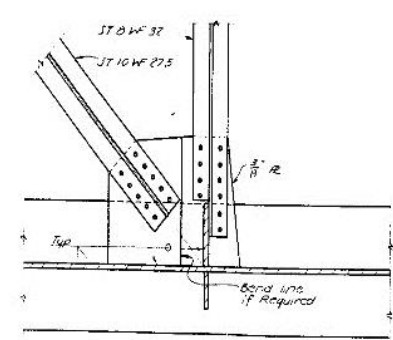
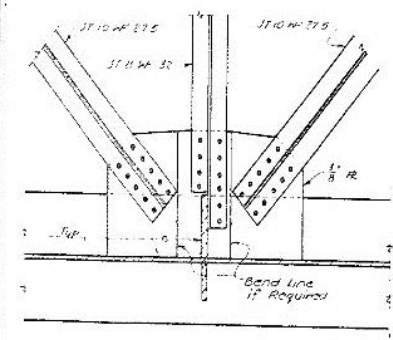
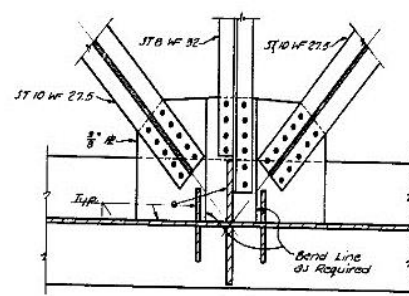
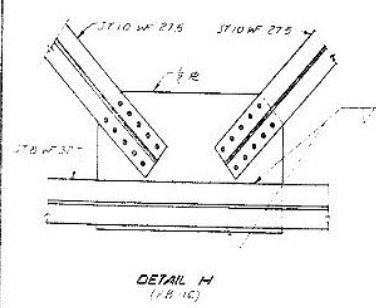

DETAIL E (FB-7, FB-15)
M. J. ...
V. H. ...
PROJECT ENGINEER
7-15-69

900' STEEL GIRDER SPAN
DETAILS OF FLOORBEAM FB-6 TO FB-20
AND LATERAL CONNECTIONS

CALCASEU RIVER BRIDGE
LAKE CHARLES-GILLIS HWY.
LA-U.S. 171

DESIGNED *D. ...* CHECKED *R. ...* TRACED *E. ...*
DATE DESCRIPTION REVISIONS BY

STATE OF LOUISIANA
DEPARTMENT OF HIGHWAYS

BRIDGE DESIGN SECTION

AS BUILT PLANS



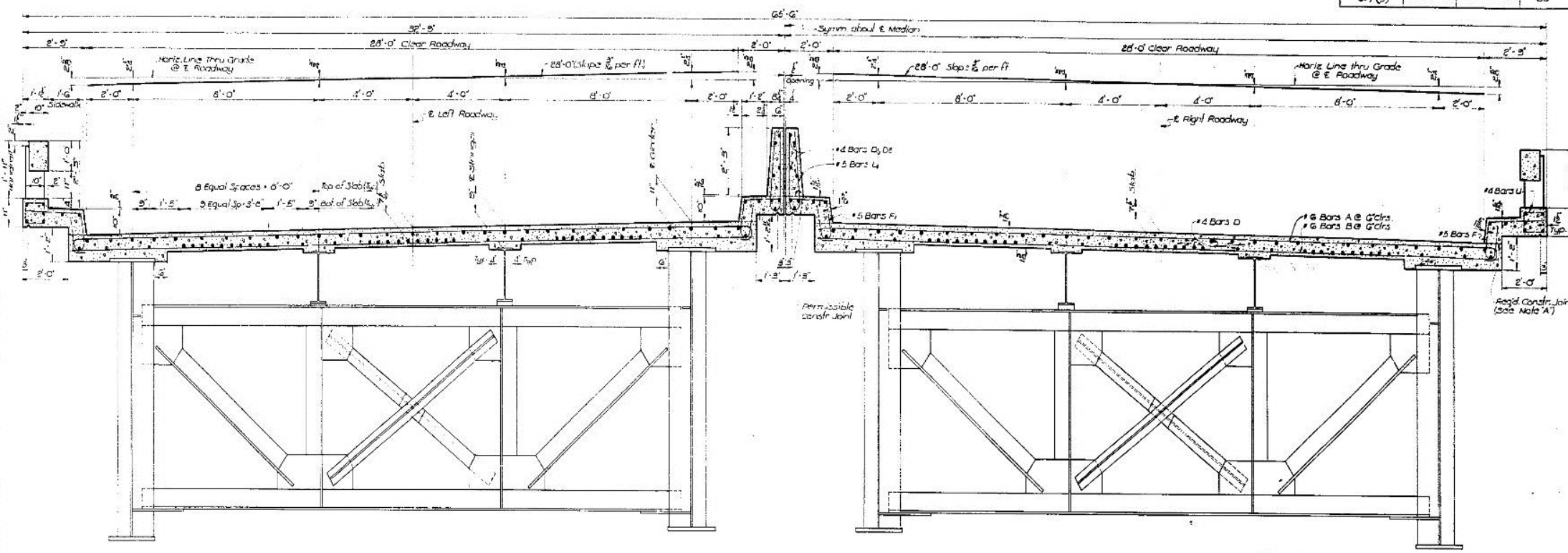

TYPICAL SECTION THRU ROADWAYS SHOWING SLAB DIMENSIONS & REINFORCING STEEL

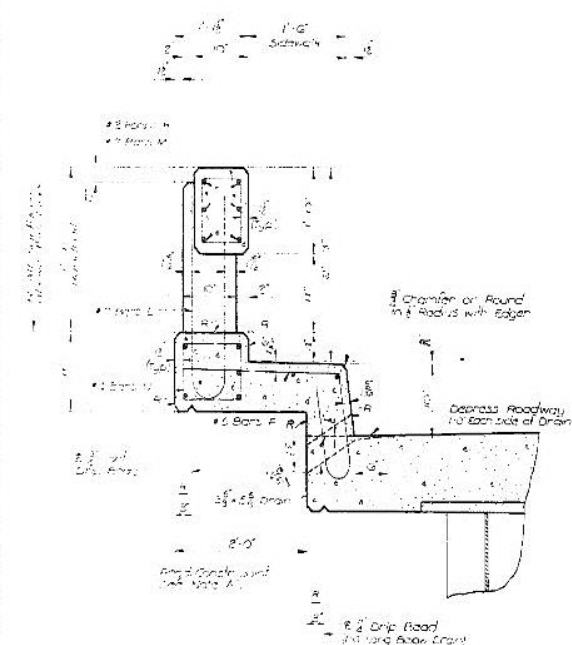

SECTION THRU OUTSIDE HANDRAIL

NOTE 'A':
When Reinforcing Bars for Roadways are a minimum of 30 days after placing of concrete in highway slab shall allow an additional 10 days for curing before any traffic is permitted on the roadway. The details of handrail steel for location of drains. Drains to be located on each side of roadway with 1/2" forming spacing. No depth required to facilitate withdrawal.

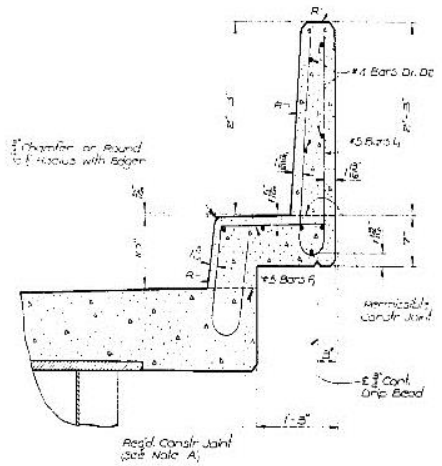

SECTION THRU MEDIAN BARRIER

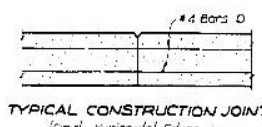

TYPICAL CONSTRUCTION JOINT

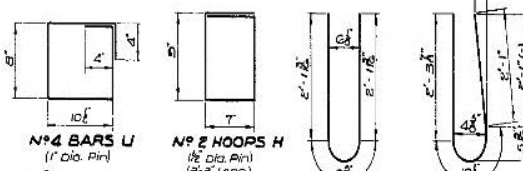
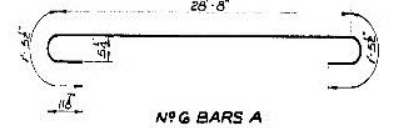

ESTIMATED QUANTITIES FOR 300' UNIT *					
BAR	SIZE	N#	UNIT LENGTH	TOTAL LENGTH	LOCATION
A	G	364	31'-7"	11424'-0"	Trans (top of slab)
B	G	364	25'-2"	9168'-0"	Trans (bottom of slab)
TOTAL N#6 BARS = 219,228'-0" = 324,627 LBS					
F	5	3975	4'-11"	17906'-0"	Sidewalk and Curb
Fi	5	3225	4'-2"	13545'-0"	Median Curb
Li	5	3690	5'-3"	19449'-0"	Median Barrier
TOTAL N#5 BARS = 32,920'-0" = 50,367 LBS					
D#	4	152	152'-0"	23004'-0"	Longit. in slab
Di	4	304	20'-1"	6100'-4"	Median Barrier
De	4	40	20'-2"	808'-0"	Median Barrier
U	4	2000	5'-5"	11000'-0"	Stirrups in Parapet
TOTAL N#4 BARS = 156,720'-0" = 112,712 LBS					
DEFORMED REINFORCING STEEL = 484,302 LBS					
CLASS 'A' CONCRETE = 11,261.15 CU YDS = 166,466 CU YDS					
CONCRETE HANDRAIL = 1779.0' LIN. FT.					
STEEL (A-36) = 2,600,491 LBS					
PREFORMED COMPRESSION SEAL FILLER = 64.97 LIN. FT.					

*Quantities shown include Left and Right Riding Bridges.
*Includes 1'-6" Min. Lap Splices.
*For General Notes see General Notes Sheet

J. H. Taylor
7/15/69

900 FT. STEEL GIRDER SPAN
(TYPICAL SECTION)
CALCASIEU RIVER BRIDGE
LAKE CHARLES-GILLIS HWY
LA-US 171
DATED JAN. 20, 1966

STATE OF LOUISIANA
DEPARTMENT OF HIGHWAYS
DESIGNED BY *R. J. Simo* D.S.M.
CHECKED BY *R. J. Simo* D.S.M.
DATE *8.1.66*
TRACED BY *D. ANDERS*
CHECKED BY *R. J. Simo*
BRIDGE DESIGN SECTION

AS BUILT PLANS

